

Simulink®

Getting Started Guide

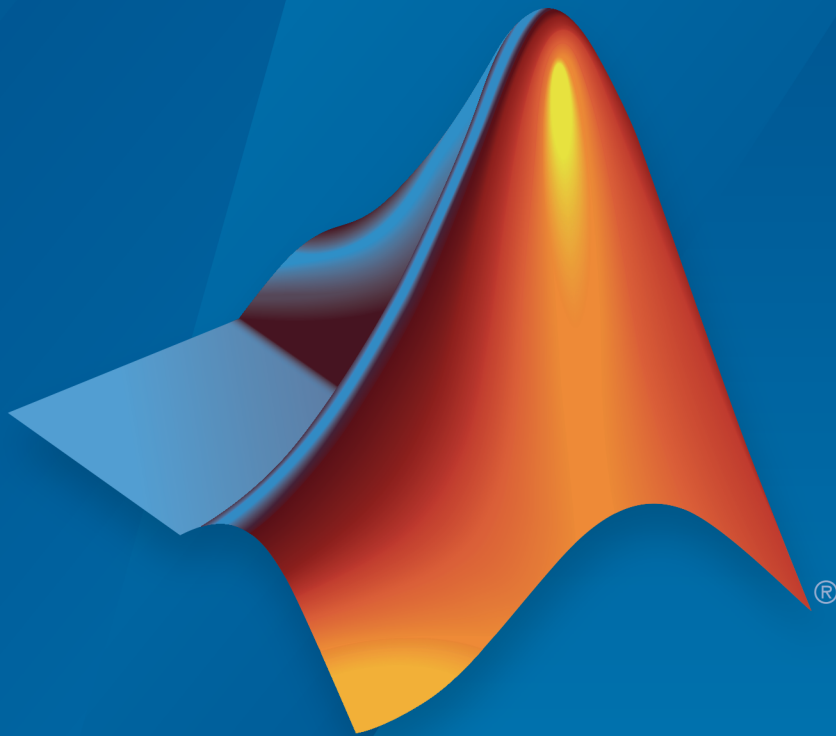

MATLAB® & SIMULINK®

R2015b



How to Contact MathWorks



Latest news: www.mathworks.com
Sales and services: www.mathworks.com/sales_and_services
User community: www.mathworks.com/matlabcentral
Technical support: www.mathworks.com/support/contact_us



Phone: 508-647-7000



The MathWorks, Inc.
3 Apple Hill Drive
Natick, MA 01760-2098

Simulink[®] Getting Started Guide

© COPYRIGHT 1990–2015 by The MathWorks, Inc.

The software described in this document is furnished under a license agreement. The software may be used or copied only under the terms of the license agreement. No part of this manual may be photocopied or reproduced in any form without prior written consent from The MathWorks, Inc.

FEDERAL ACQUISITION: This provision applies to all acquisitions of the Program and Documentation by, for, or through the federal government of the United States. By accepting delivery of the Program or Documentation, the government hereby agrees that this software or documentation qualifies as commercial computer software or commercial computer software documentation as such terms are used or defined in FAR 12.212, DFARS Part 227.72, and DFARS 252.227-7014. Accordingly, the terms and conditions of this Agreement and only those rights specified in this Agreement, shall pertain to and govern the use, modification, reproduction, release, performance, display, and disclosure of the Program and Documentation by the federal government (or other entity acquiring for or through the federal government) and shall supersede any conflicting contractual terms or conditions. If this License fails to meet the government's needs or is inconsistent in any respect with federal procurement law, the government agrees to return the Program and Documentation, unused, to The MathWorks, Inc.

Trademarks

MATLAB and Simulink are registered trademarks of The MathWorks, Inc. See www.mathworks.com/trademarks for a list of additional trademarks. Other product or brand names may be trademarks or registered trademarks of their respective holders.

Patents

MathWorks products are protected by one or more U.S. patents. Please see www.mathworks.com/patents for more information.

Revision History

September 2005	Online only	New for Version 6.3 (Release 14SP3)
March 2006	Online only	Revised for Simulink 6.4 (Release 2006a)
September 2006	Online only	Revised for Simulink 6.5 (Release 2006b)
March 2007	First printing	Revised for Simulink 6.6 (Release 2007a)
September 2007	Second printing	Revised for Simulink 7.0 (Release 2007b)
March 2008	Third printing	Revised for Simulink 7.1 (Release 2008a)
October 2008	Fourth printing	Revised for Simulink 7.2 (Release 2008b)
March 2009	Fifth printing	Revised for Simulink 7.3 (Release 2009a)
September 2009	Online only	Revised for Simulink 7.4 (Release 2009b)
March 2010	Online only	Revised for Simulink 7.5 (Release 2010a)
September 2010	Online only	Revised for Simulink 7.6 (Release 2010b)
April 2011	Online only	Revised for Simulink 7.7 (Release 2011a)
September 2011	Sixth printing	Revised for Simulink 7.8 (Release 2011b)
March 2012	Seventh printing	Revised for Simulink 7.9 (Release 2012a)
September 2012	Eighth printing	Revised for Simulink 8.0 (Release 2012b)
March 2013	Ninth printing	Revised for Simulink 8.1 (Release 2013a)
September 2013	Tenth printing	Revised for Simulink 8.2 (Release 2013b)
March 2014	Eleventh printing	Revised for Simulink 8.3 (Release 2014a)
October 2014	Twelfth printing	Revised for Simulink 8.4 (Release 2014b)
March 2015	Thirteenth printing	Revised for Simulink 8.5 (Release 2015a)
September 2015	Fourteenth printing	Revised for Simulink 8.6 (Release 2015b)

Introduction

1

Simulink Product Description	1-2
Key Features	1-2
Model-Based Design	1-3
What Is Model-Based Design?	1-3
Modeling, Simulation, and Analysis with Simulink	1-4
Interaction with MATLAB Environment	1-5
Basic Modeling Workflow	1-6
Define System	1-6
Model System	1-9
Integrate Model	1-11
Basic Simulation Workflow	1-13
Prepare for Simulation	1-13
Run and Evaluate Simulation	1-15
Documentation and Resources	1-17
Simulink Online Help	1-17
Simulink Examples	1-18
Website Resources	1-18

Simple Simulink Model

2

Create a Simple Model	2-2
Model Overview for This Tutorial	2-2
Open the Simulink Library Browser	2-4
Browse or Search for Specific Blocks	2-5

Open a New Model in the Simulink Editor	2-6
Add Blocks to a Model	2-6
Move and Resize Blocks	2-9
Simulink Block Connections	2-10
Draw Signal Lines Between Blocks	2-10
Draw Branched Signal Lines	2-13
Define Simulation Parameters	2-15
Run Simulation	2-16
Observe Simulation Results	2-16

Model a Dynamic System

3

Model a Dynamic System	3-2
Define a House Heating System	3-2
Model a House Heating System	3-7
Integrate a House Heating Model	3-24

Basic Simulation Workflow

4

Simulate a Dynamic System	4-2
Prepare Simulation	4-2
Run and Evaluate Simulation	4-5

Introduction

- “Simulink Product Description” on page 1-2
- “Model-Based Design” on page 1-3
- “Basic Modeling Workflow” on page 1-6
- “Basic Simulation Workflow” on page 1-13
- “Documentation and Resources” on page 1-17

Simulink Product Description

Simulation and Model-Based Design

Simulink is a block diagram environment for multidomain simulation and Model-Based Design. It supports system-level design, simulation, automatic code generation, and continuous test and verification of embedded systems. Simulink provides a graphical editor, customizable block libraries, and solvers for modeling and simulating dynamic systems. It is integrated with MATLAB[®], enabling you to incorporate MATLAB algorithms into models and export simulation results to MATLAB for further analysis.

Key Features

- Graphical editor for building and managing hierarchical block diagrams
- Libraries of predefined blocks for modeling continuous-time and discrete-time systems
- Simulation engine with fixed-step and variable-step ODE solvers
- Scopes and data displays for viewing simulation results
- Project and data management tools for managing model files and data
- Model analysis tools for refining model architecture and increasing simulation speed
- MATLAB Function block for importing MATLAB algorithms into models
- Legacy Code Tool for importing C and C++ code into models

Model-Based Design

In this section...

“What Is Model-Based Design?” on page 1-3

“Modeling, Simulation, and Analysis with Simulink” on page 1-4

“Interaction with MATLAB Environment” on page 1-5

What Is Model-Based Design?

Model-Based Design is a process that enables fast and cost-effective development of dynamic systems, including control systems, signal processing, and communications systems. In Model-Based Design, a system model is at the center of the development process, from requirements development through design, implementation, and testing. The model is an executable specification that you continually refine throughout the development process. After model development, simulation shows whether the model works correctly.

When software and hardware implementation requirements are included with the model, such as fixed-point and timing behavior, you can generate code for embedded deployment and create test benches for system verification, saving time and avoiding manually coded errors.

Model-Based Design allows you to improve efficiency by:

- Using a common design environment across project teams
- Linking designs directly to requirements
- Integrating testing with design to continuously identify and correct errors
- Refining algorithms through multi-domain simulation
- Generating embedded software code
- Developing and reusing test suites
- Generating documentation
- Reusing designs to deploy systems across multiple processors and hardware targets

Modeling, Simulation, and Analysis with Simulink

With Simulink, you can move beyond idealized linear models to explore realistic nonlinear models, factoring in friction, air resistance, gear slippage, hard stops, and the other parameters that describe real-world phenomena. Simulink enables you to think of the development environment as a laboratory for modeling and analyzing systems that would not be possible or practical otherwise.

Whether you are interested in the behavior of an automotive clutch system, the flutter of an airplane wing, or the effect of the monetary supply on the economy, Simulink provides you with the tools to model and simulate almost any real-world problem. Simulink also provides examples that model a wide variety of real-world phenomena.

Tool for Modeling

Simulink provides a graphical editor for building models as block diagrams, allowing you to draw models as you would with pencil and paper. Simulink also includes a comprehensive library of sink, source, linear and nonlinear component, and connector blocks. If these blocks do not meet your needs, however, you can also create your own blocks. The interactive environment simplifies the modeling process, eliminating the need to formulate differential and difference equations in a language or program.

Models are hierarchical, so you can build models using both top-down and bottom-up approaches. You can view the system at a high level, then drill down to see increasing levels of model detail. This approach provides insight into how a model is organized and how parts interact.

Tool for Simulation

After you define a model, you can simulate its dynamic behavior using a choice of mathematical integration methods, either interactively in Simulink or by entering commands in the MATLAB Command Window. Commands are particularly useful for running a batch of simulations. For example, if you are doing Monte Carlo simulations or want to apply a parameter across a range of values, you can use MATLAB scripts.

Using scopes and other display blocks, you can see the simulation results while a simulation runs. You can then change parameters and see what happens for “what if” exploration. You can save simulation results in the MATLAB workspace for postprocessing and visualization.

Tool for Analysis

Model analysis tools include linearization and trimming tools you can access from MATLAB, plus the many tools in MATLAB and its application toolboxes. Because MATLAB and Simulink are integrated, you can simulate, analyze, and revise your models in either environment.

Interaction with MATLAB Environment

Simulink software requires MATLAB to run, and it depends on it to define and evaluate model and block parameters. Simulink can also use many MATLAB features. For example, Simulink can use the MATLAB environment to:

- Define model inputs.
- Store model outputs for analysis and visualization.
- Perform functions within a model, through integrated calls to MATLAB operators and functions.

Basic Modeling Workflow

In this section...

“Define System” on page 1-6

“Model System” on page 1-9

“Integrate Model” on page 1-11

Modeling is a process in which you describe a dynamic system with mathematical equations and then create a simplified representation of the system with a model. The equations define the science of the system and the model uses the equations to define the time-varying behavior.

The steps in a typical modeling workflow include:

- Defining a system
- Modeling the system
- Integrating the system

Define System

Identify the components of a system, determine physical characteristics, and define dynamic behavior with equations. You perform these steps outside of the Simulink software environment and before you begin building your model.

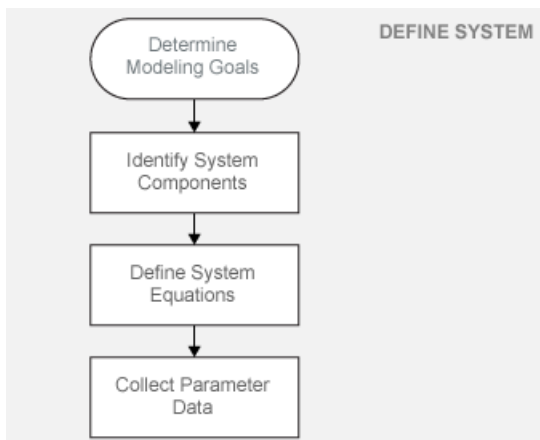

Determine Modeling Goals

Before designing a model, you need to understand your goals and requirements. Ask yourself these questions to help plan your model design:

- What problem does the model help you solve?
- What questions can it answer?
- How accurately must it represent the system?

Some possible modeling goals:

- Understand how system components interact with each other.
- Explore controller and fault-tolerance strategies.
- Decide between alternative designs.
- Observe the response of systems that you cannot solve analytically.
- Determine how various inputs and changing model parameters affect the output.

Identify System Components

Once you understand your modeling requirements, you can begin to identify the components of the system.

- Identify the components that correspond to structural parts of the system. Creating a model that reflects the physical structure of a system, for example, motor controller or brake system, is helpful when you have to build part of the system in software and hardware.
- Identify functional parts that you can independently model and test.
- Describe the relationships between components, for example, data, energy, and force transfer.
- Draw a picture showing the connections between components. Include major parameters in your diagram. Creating a picture of the system can help you identify and model the parts that are essential to the behaviors you want to observe.

Define System Equations

After you identify the components in a system, you can describe the system mathematically with equations. Derive the equations using scientific principles or from the input-output response of measured data. Many of the system equations fall into three categories:

- For continuous systems, differential equations describe the rate of change for variables with the equations defined for all values of time. For example, the velocity of a car is given by the second order differential equation

$$\frac{dv(t)}{dt} = -\frac{b}{m}v(t) + u(t).$$

- For discrete systems, difference equations describe the rate of change for variables, but the equations are defined only at specific times. For example, the control signal from a discrete propositional-derivative controller is given by the difference equation

$$pd[n] = (e[n] - e[n-1])K_d + e[n]K_p.$$

- Equations without derivatives are algebraic equations. For example, the total current in a parallel circuit with two components is given by the algebraic equation

$$I_t = I_a + I_b.$$

Collect Parameter Data

Create a list of equation variables and constant coefficients, and then determine the coefficient values from published sources or by performing experiments on the system.

Use measured data from a system to define equation coefficients and parameters in your model.

- Identify the parts that are measurable in a system.
- Measure physical characteristics or use published property values. Manufacturer data sheets are a good source for hardware values.
- Perform experiments to measure the system response to various inputs. You will later use this data to verify your model design with simulations.

Model System

Build individual model components that implement the system equations, and define the interfaces for passing data between components.

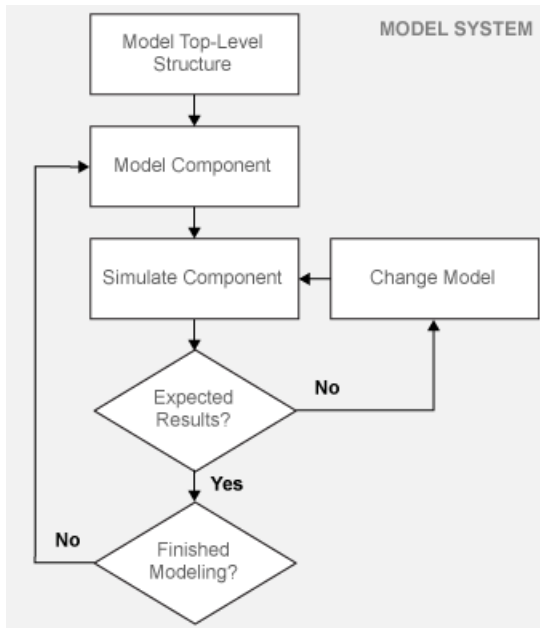

Model Top-Level Structure

A model in Simulink is a graphical representation of a system using blocks and connections between blocks. After you finish describing your system, its components, and equations, you can begin to build your model.

- Use the system equations to build a graphical model of the system with the Simulink Editor.
- If you place all of the model blocks in one level of a diagram, your diagram can become difficult to read and understand. One way to organize your model is to use subsystems. Examples of blocks you can use to create a subsystem include Subsystem, Atomic Subsystem, and Model.
- Identify input and output connections (for example, signal lines) between subsystems. Input and output values change dynamically during a simulation.

Model Component

Some questions to ask before you begin to model a component:

- What are the constants for each component and the values that do not change unless you change them?
- What are the variables for each component and the values that change over time?
- How many state variables does a component have?

After you create the top-level structure for your model, you can begin to model the individual components.

- Use the system equations to create a Simulink model.
- Add Simulink blocks in the Simulink Editor. Blocks represent coefficients and variables from the equations. Connect blocks to other blocks. Lines connecting blocks represent data transfer.
- Build the model for each component separately. The most effective way to build a model of a system is to consider components independently.
- Start by building simple models using approximations of the system. Identify assumptions that can affect the accuracy of your model. Iteratively add detail until the level of complexity satisfies the modeling and accuracy requirements.

Simulate Component

After you build a model component, you can simulate to validate the design.

- Predict the expected output of the integrated model components.
- Add blocks to approximate actual input and control values. Add sink blocks to record and visualize results.
- Validate the model design by comparing the simulation output to your expected output.
- If the result does not match your prediction, change your model to improve the accuracy of your prediction. Changes include model structure and parameters.

Integrate Model

Connect component models and simulate the model response over time to validate the design.

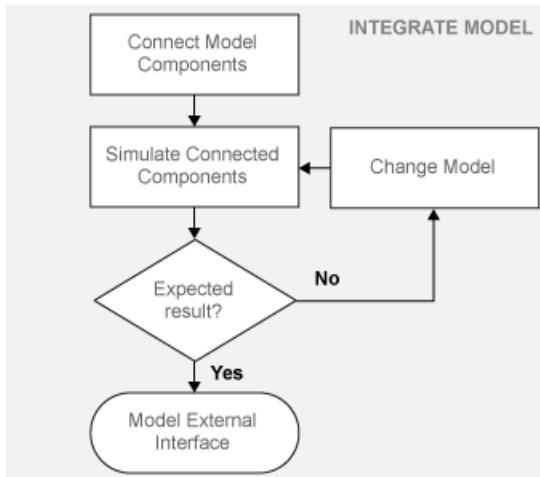

Connect Model Components

After you build and validate each model component, you can connect them into a complete model, simulate the model, and analyze the results.

Some guidelines for connecting model components:

- Integrate model components by first connecting two of them (for example, connect a plant to a controller). After validating the pair by simulation, continue connecting components until your model is complete.
- Think about how each component you add affects the other parts of the model.

Simulate Connected Components

Validating your model determines if it accurately represents the physical characteristics of the modeled dynamic system. Some guidelines for validating subsystems:

- Predict the expected simulation results and outputs of the subsystems.
- Add realistic inputs using source blocks.
- Add sink blocks to record and visualize results.
- Simulate the subsystems and compare the simulated result with your expected result.

Model External Interface

Add blocks for connecting external signals into and out of your model.

Basic Simulation Workflow

In this section...

“Prepare for Simulation” on page 1-13

“Run and Evaluate Simulation” on page 1-15

Simulation is a process in which you validate and verify a model by comparing simulation results with:

- Data collected from a real system.
- Functionality described in the model requirements.

Perform the simulation workflow after you've finished building your model and a simulation completes without errors. The steps in a typical simulation workflow include:

- Prepare for simulation.
- Run and evaluate simulation.

Prepare for Simulation

Define the external input and output interfaces.

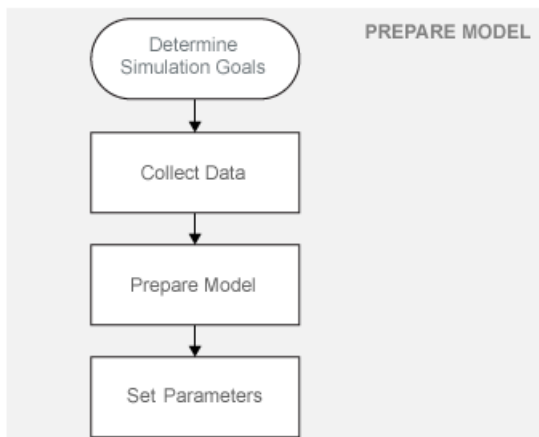

Determine Simulation Goals

Before simulating a model, you need to understand your goals and requirements. Ask yourself these questions to help plan your simulations:

- What questions do you want the simulation to answer?
- How accurately does the model need to represent the system?

Some possible simulation goals:

- Understand input to output causality — For a given input set and nominal parameter values, look at how the inputs flow through the system to the outputs.
- Verify model — Compare simulation results with collected data from the modeled system. Iteratively debug and improve the design.
- Optimize parameters — Change parameters and compare simulation runs.
- Visualize results — Send simulation results to a plot or print in a report.

Collect Data

Collect input and output data from an actual system. Use measured input data to drive the simulation. Use measured output data to compare with the simulation results from your model.

You will use measured input data to drive a simulation and measured output data to verify the simulation results.

Prepare Model

Preparing a model for simulation includes defining the external interfaces for input data and control signals, and output signals for viewing and recording simulation results.

Set Parameters

For the first simulation, use model parameters from the validated model. After comparing the simulation results with measured output data, change model parameters to more accurately represent the modeled system.

Run and Evaluate Simulation

Simulate your model and verify that the simulation results match the measured data from the modeled system.

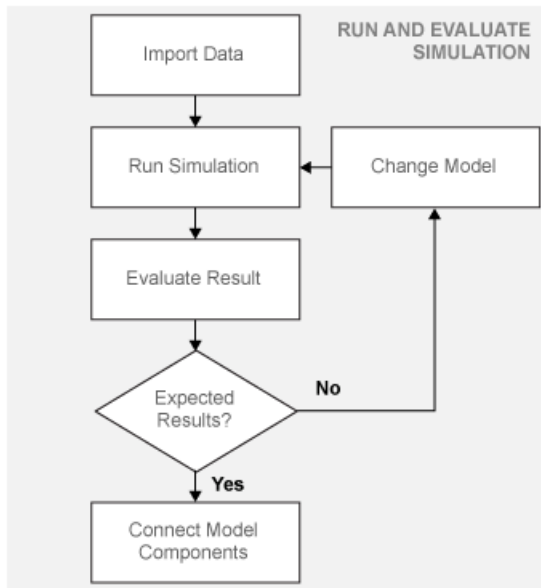

Import Data

Simulink enables you to import data into your model.

- Use the Signal Builder block to import input signals from a Microsoft[®] Excel[®] file (XLSX, XLS) or a comma-separated value file (CSV). Simulink saves data imported from an Excel file using a Signal Builder block with the model and loads the data into memory when you open the model.
- For large data sets, use a MATLAB MAT-file with an Inport block.

Run Simulation

Using measured input data, run a simulation and save results.

Evaluate Result

Evaluate the differences between simulated output and measured output data. Use the evaluation to verify the accuracy of your model and how well it represents the system behavior. Decide if the accuracy of your model adequately represents the dynamic system you are modeling.

Change Model

Determine the changes to improve your model. Model changes include:

- Parameters — Some parameters were initially estimated and approximated. Optimize and update parameters.
- Adding structure — Some parts or details of the system were not modeled. Add missing details.

Documentation and Resources

In this section...
“Simulink Online Help” on page 1-17
“Simulink Examples” on page 1-18
“Website Resources” on page 1-18

Simulink Online Help

Simulink software provides comprehensive online help describing features, blocks, and functions with detailed procedures for common tasks.

Access online help from **Help** menus and context-sensitive block labels.

- From the Simulink Library Browser, select **Help > Simulink Help**.
- From the Simulink Editor, select **Help > Simulink > Simulink Help**.
- Right-click a Simulink block, and then select **Help**.
- From the model Configuration Parameters or a block parameters dialog box, right-click a parameter label, then select **What's This?**

Simulink Examples

Simulink provides example models that illustrate key modeling concepts and Simulink features.

You can access these examples from the **Help** menu or from the documentation.

- From the Simulink Editor, select **Help > Simulink > Examples**.
- From the documentation, click **Examples** at the top of the product landing page.



Featured examples include a button at the top of the Help browser for opening the model in the Simulink Editor.

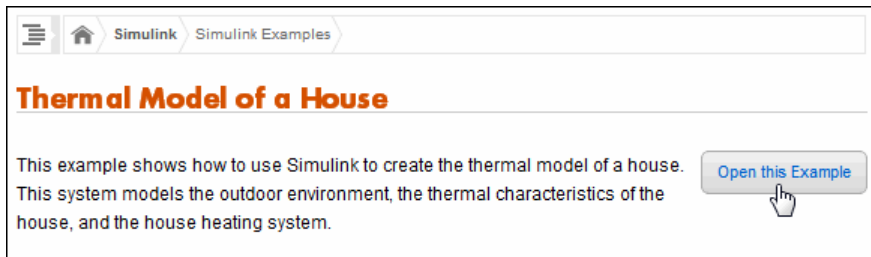

Website Resources

You can access additional Simulink resources on the MathWorks® website, including Simulink related books, webinars, and technical support.

To access the Simulink product page, go to

<http://www.mathworks.com/products/simulink>

Simple Simulink Model

Create a Simple Model

In this section...

“Model Overview for This Tutorial” on page 2-2
“Open the Simulink Library Browser” on page 2-4
“Browse or Search for Specific Blocks” on page 2-5
“Open a New Model in the Simulink Editor” on page 2-6
“Add Blocks to a Model” on page 2-6
“Move and Resize Blocks” on page 2-9
“Simulink Block Connections” on page 2-10
“Draw Signal Lines Between Blocks” on page 2-10
“Draw Branched Signal Lines” on page 2-13
“Define Simulation Parameters” on page 2-15
“Run Simulation” on page 2-16
“Observe Simulation Results” on page 2-16

Model Overview for This Tutorial

You can use Simulink to model a system and then simulate the dynamic behavior of that system. The basic techniques you use to create the simple model in this tutorial are the same techniques that you use for more complex models.

To create this simple model, you need four Simulink blocks:

- Sine Wave — Generates an input signal for the model.
- Integrator — Processes the input signal.
- Bus Creator — Combines the input signal and processed signal into one signal.
- Scope — Visualizes the signals.

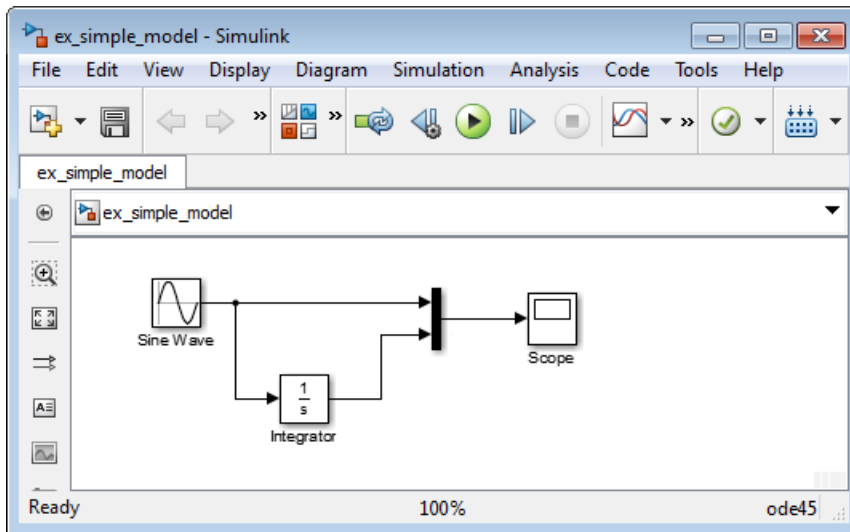

Simulating this model integrates a sine wave signal to a cosine signal and then displays the result, along with the original signal, in a scope window.

Open the Simulink Library Browser

From the Simulink Library Browser, you can create a model (block diagram) and search for blocks that you want to use in your model. You need MATLAB running before you can open the Simulink Library Browser.

- 1 From the MATLAB Toolstrip, click the **Simulink Library** button , or in the **Command Window**, enter

```
simulink
```

A short delay occurs the first time you open the Simulink Library Browser.

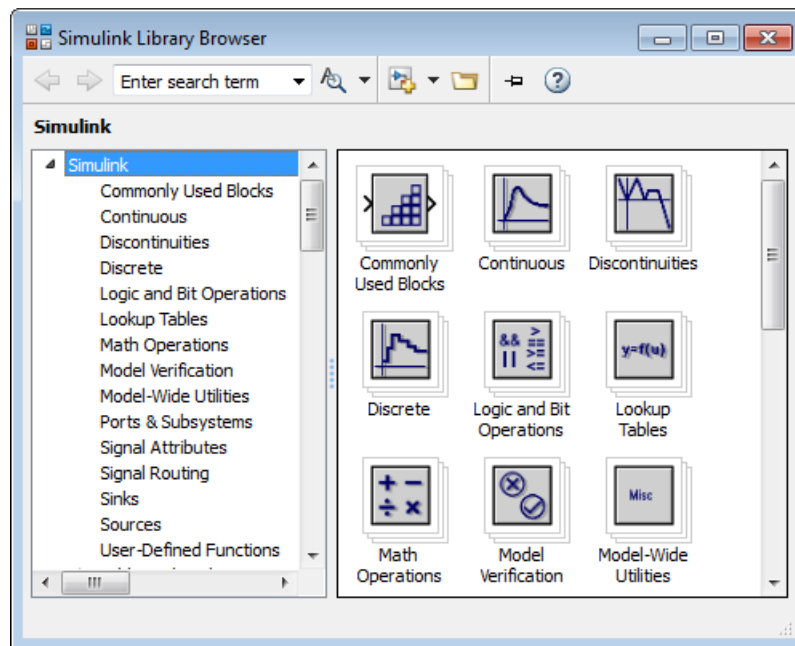

- 2 Set the Library Browser to stay on top of the other desktop windows. On the Library Browser toolbar, select the **Stay on top** button .

Browse or Search for Specific Blocks

To browse through the block libraries, select a MathWorks product and a functional area in the left pane. Alternatively, you can search all the available block libraries at once.

- 1 Search for a Sine Wave block. In the search box on the browser toolbar, enter `sine`, and then press the Enter key. Simulink searches the libraries for blocks with `sine` in their name, and then displays the blocks.

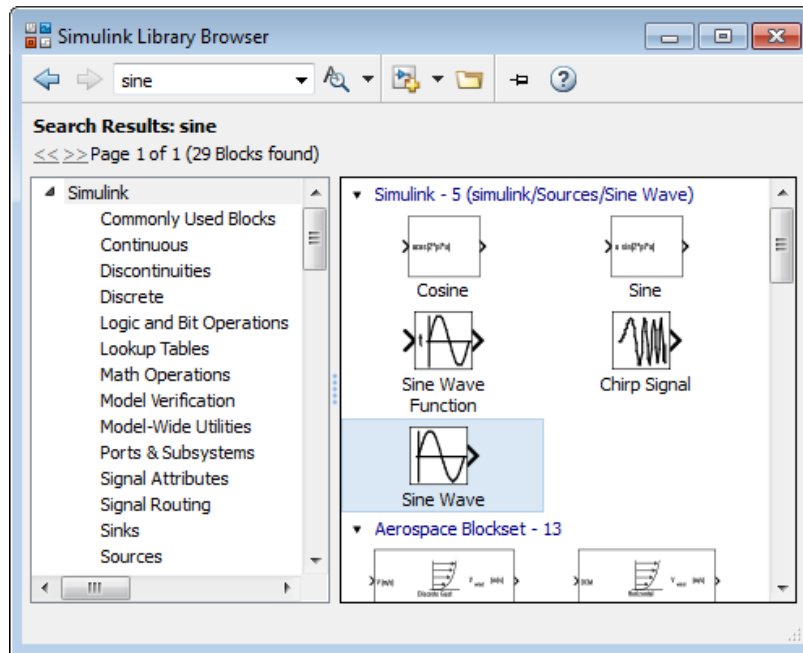

- 2 Get detailed information about a block. Right-click a block, and then select **Help for the <block name>**. The Help browser opens with the reference page for the block.
- 3 View block parameters. Right-click a block, and then select **Block Parameters**. The block parameters dialog box opens.

Open a New Model in the Simulink Editor

In the Simulink Editor, you can build and simulate models of your system. You need the Simulink Library Browser open before you can create a Simulink model.

- 1 From the Simulink Library Browser toolbar, click the **New Model** button . A Simulink Editor window opens with a new block diagram.

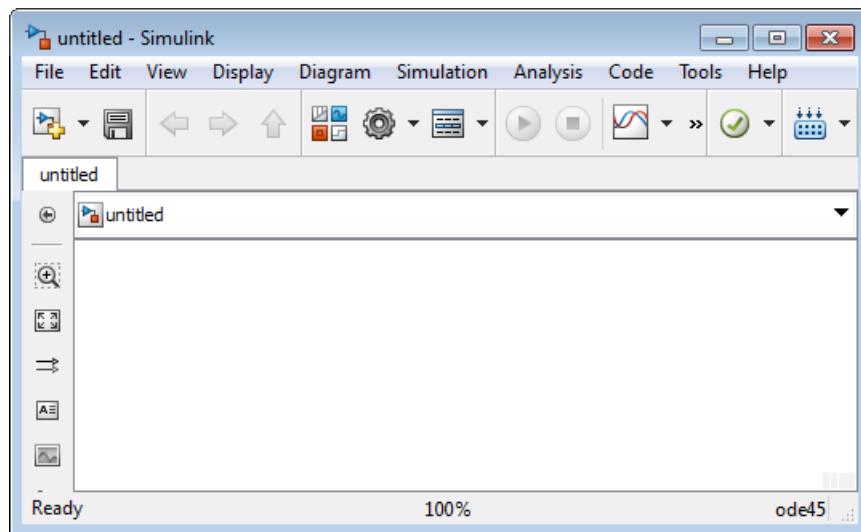

- 2 Select **File > Save as**. In the **File name** text box, enter a name for your model. For example, enter `simple_model`, and then click **Save**.

Simulink saves your model with the file name `simple_model.slx`.

Add Blocks to a Model

You build models by dragging blocks from the Simulink Library Browser window to the Simulink Editor window or single-clicking your model and entering a search term.

To build a model, begin by copying blocks from the Simulink Library Browser to the Simulink Editor.

- 1 In the Simulink Library Browser, select the **Sources** library.

- 2 From the right pane, select the Sine Wave block.

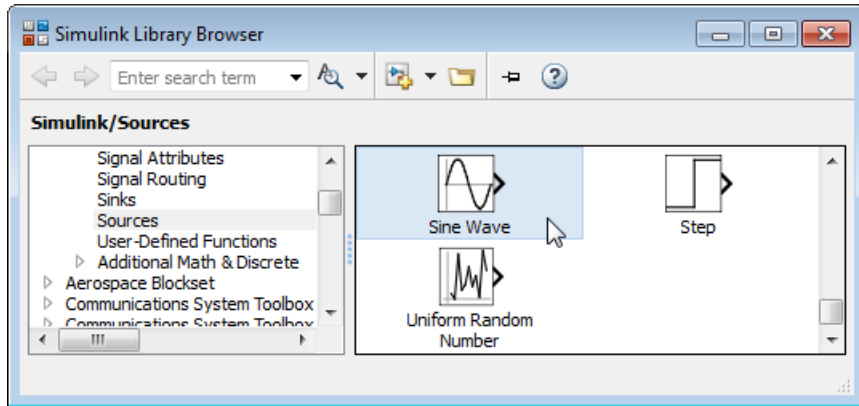

- 3 Drag the Sine Wave block to the Simulink Editor. A copy of the Sine Wave block appears in your model.

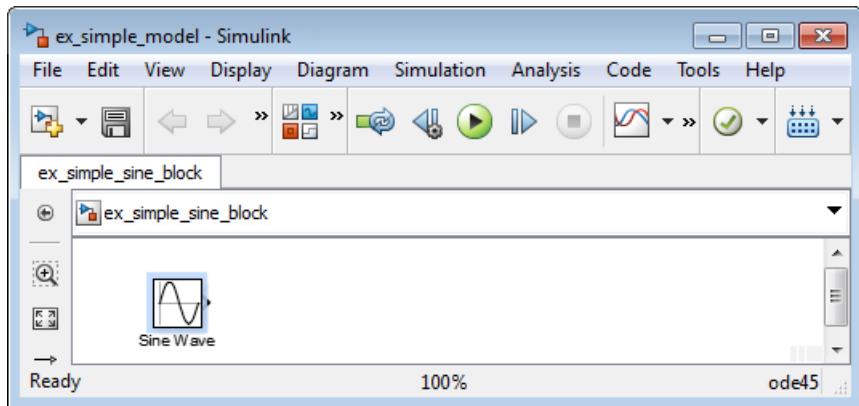

- 4 Add a Scope block using this alternative procedure:
 - a Click within the block diagram.
 - b After the search icon appears, type **scope**, and then from the list, select **Scope**.

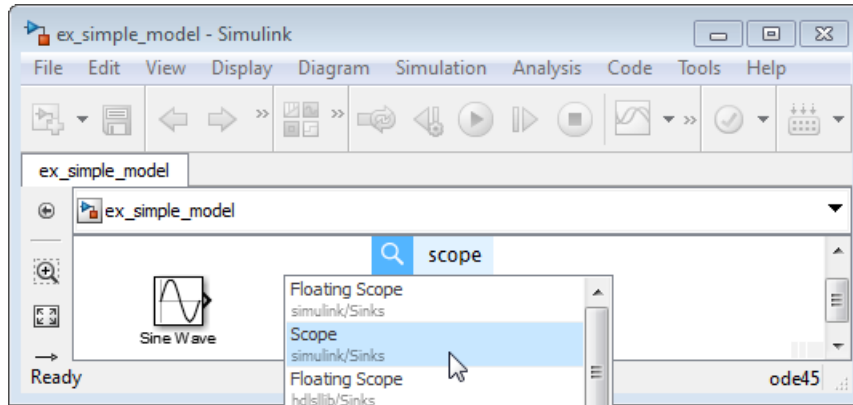

- 5 Add the following blocks to your model, using the approach that you used to add the Sine Wave and Scope blocks.

Library	Block
Continuous	Integrator
Signal Routing	Bus Creator

Your model should now have the blocks you need for the simple model.

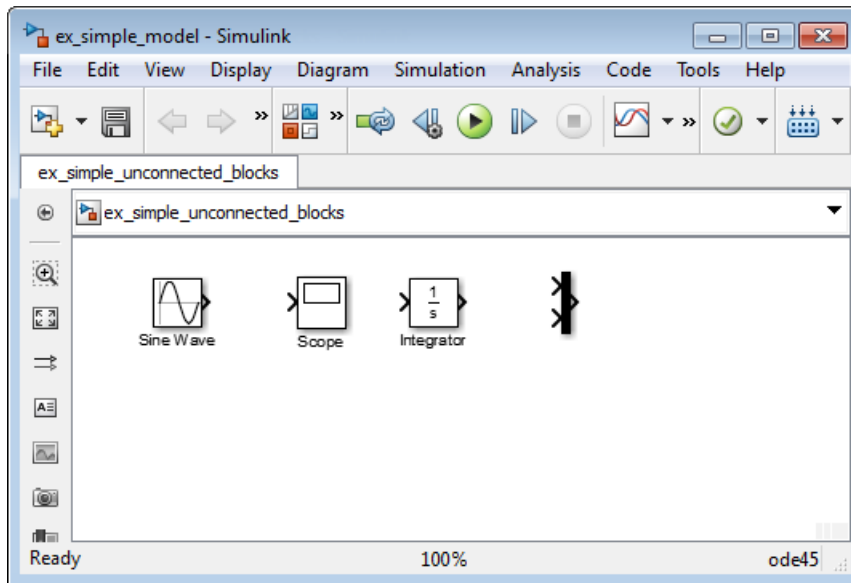

Move and Resize Blocks

Before you connect the blocks in your model, arrange them logically to make the signal connections as straightforward as possible.

- 1 Move the Scope block after the Bus block output. You can either:
 - Click and drag a block.
 - Select the block, and then press the arrow keys on your keyboard.
- 2 Move the blocks until your model looks similar to the following figure.

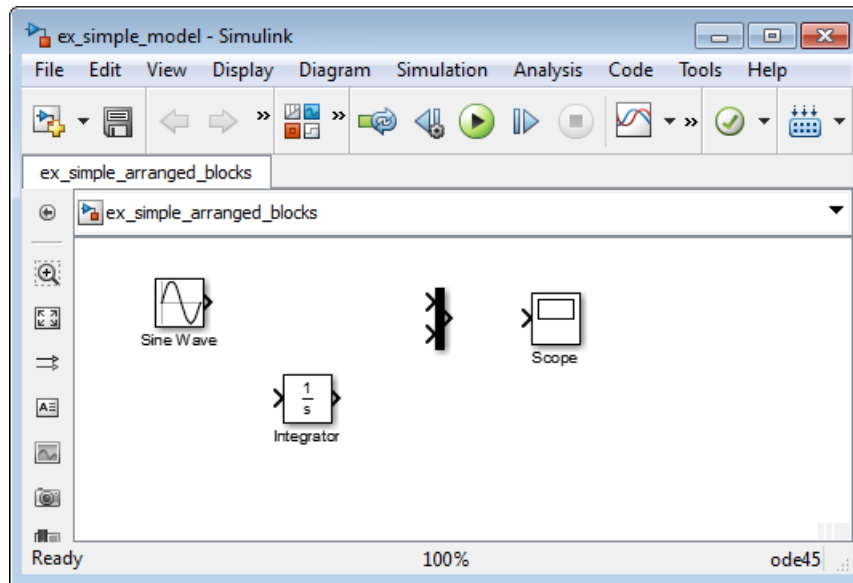

Simulink Block Connections

After you add blocks to your model, you can connect them with lines. The connecting lines represent signals within your model.

Most blocks have angle brackets on one or both sides. These angle brackets represent input and output ports:

- The $>$ symbol pointing into a block is an *input port*.
- The $>$ symbol pointing out of a block is an *output port*.

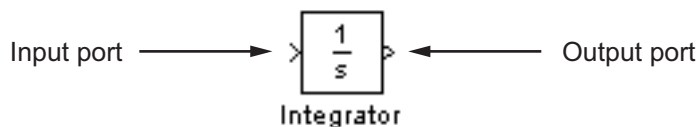

Draw Signal Lines Between Blocks

Connect the blocks by drawing lines between output ports and input ports.

- 1 Position the cursor over the output port on the right side of the Sine Wave block.

The pointer changes to a cross hair (+) while over the port.

- 2 Click, and then drag a line from the output port to the top input port of the Bus block.

While you are holding down the mouse button, the connecting line appears as a red dotted arrow.

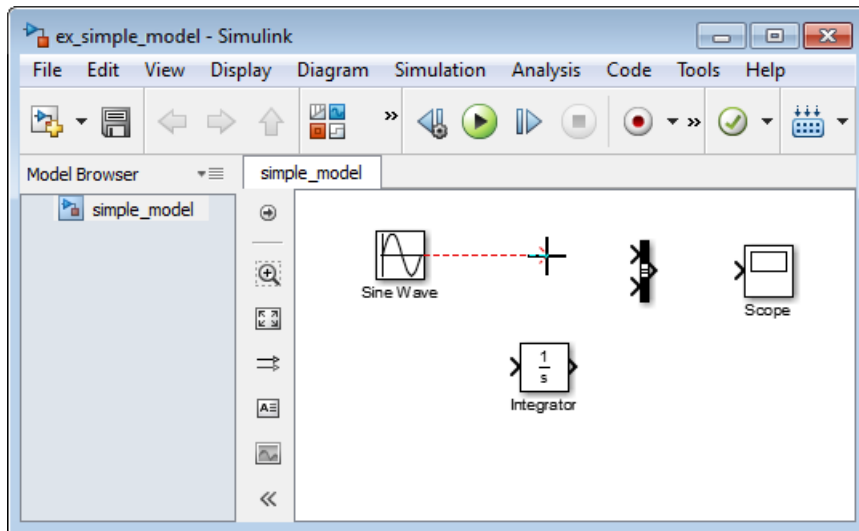

- 3 Release the mouse button when the pointer is over the output port.

Simulink connects the blocks with a line and an arrow indicating the direction of signal flow.

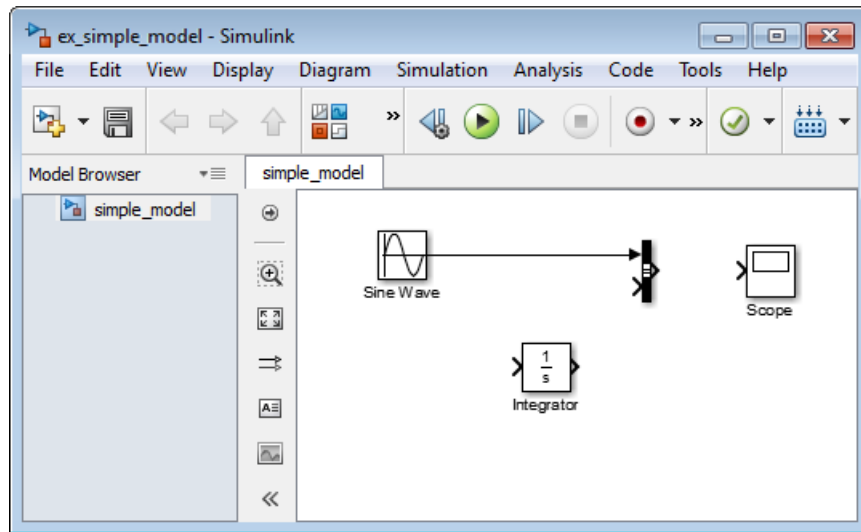

- 4 Connect the output port of the Integrator block to the bottom input port on the Bus Connector block using this alternative procedure:
 - a Select the Integrator block.
 - b Press and hold the **Ctrl** key.
 - c Click the Bus Connector block.

The Integrator block connects to the Bus Connector block with a signal line.

Note: The **Ctrl+click** shortcut is useful when you are connecting widely separated blocks or when working with complex models.

- 5 Connect the Bus Connector block to the Scope block by aligning ports:
 - a Click and drag the Scope block until its input port is aligned with the Bus Connector output port. A light blue line appears between the ports.
 - b Release the mouse button, and then click the blue arrow. The blue arrow changes to a black signal line connecting the blocks.

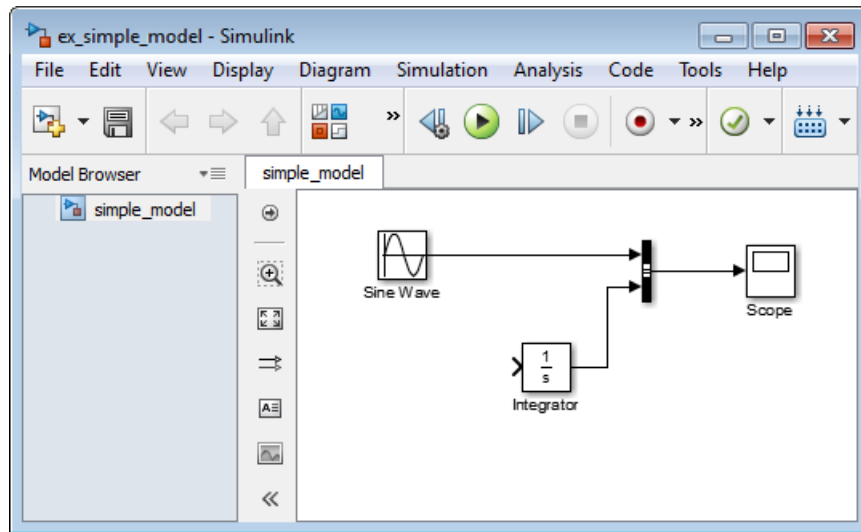

Draw Branched Signal Lines

Your simple model is almost complete. To finish the model, connect the Sine Wave block to the Integrator block. This connection is different from the other connections, which all connect output ports to input ports.

- 1 Hold down the **Ctrl** key.
- 2 Position the cursor where you want to start a branch line. Click, and then drag the cursor away from the line to form a dotted-red line segment.

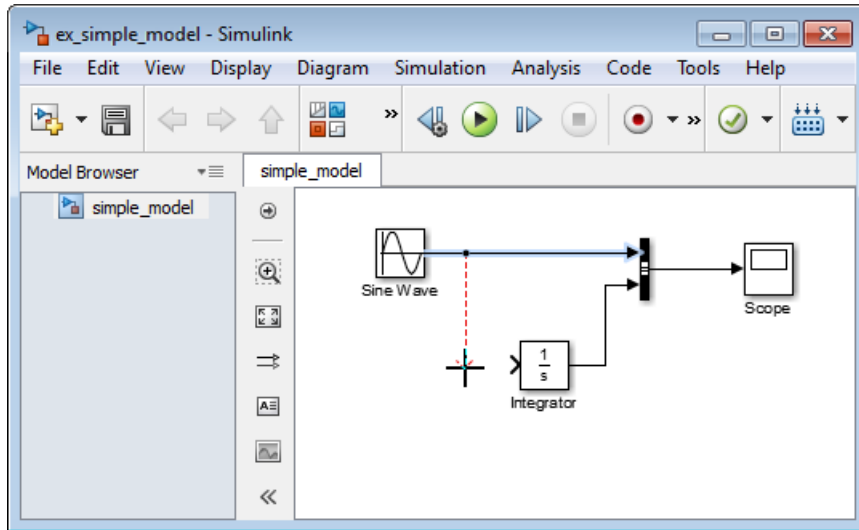

- 3 Drag the cursor to the Integrator input port, and then release the mouse button.

The new line, called a *branch line*, carries the same signal that passes from the Sine Wave block to the Bus block.

- 4 Drag line segments to straighten and align with blocks. Your model is now complete.

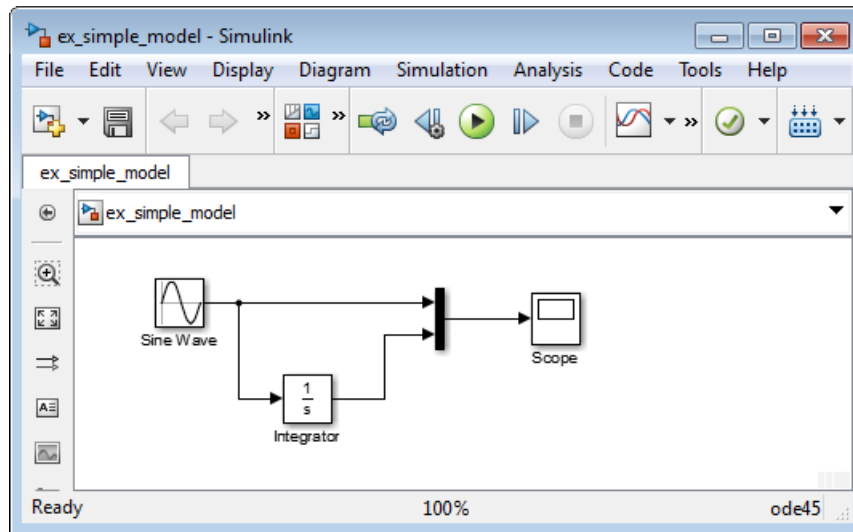

Define Simulation Parameters

Before you simulate the behavior of a model, define the simulation parameters. Simulation parameters include the type of numerical solver, start, and stop times, and maximum step size.

- 1 From the Simulink Editor menu, select **Simulation > Model Configuration Parameters**. The Configuration Parameters dialog box opens to the **Solver** pane.

Tip Alternatively, you can open the Model Configuration Parameters dialog box by clicking the parameters button  on the Simulink Editor toolbar.

- 2 In the **Stop time** field, enter 20. In the **Max step size** field, enter 0.2.

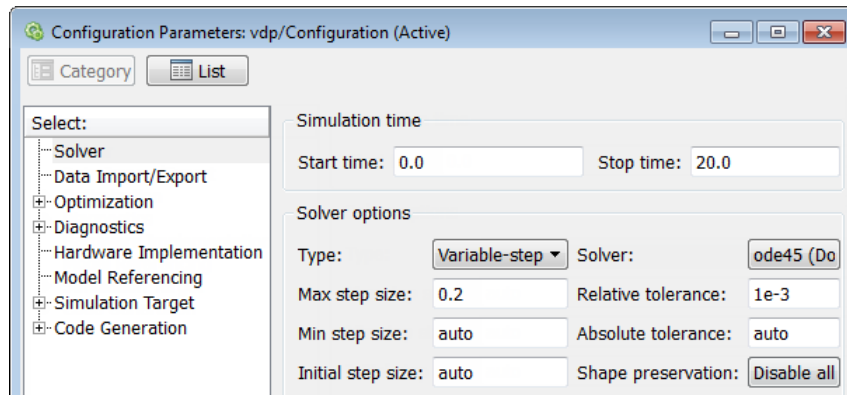

- 3 Click **OK**.



Run Simulation

After you define the Model Configuration Parameters, you are ready to simulate your model.

- 1 From the Simulink Editor menu bar, select **Simulation > Run**.

The simulation runs, and then stops when it reaches the stop time specified in the Model Configuration Parameters dialog box.

Tip Alternatively, you can control a simulation by clicking the **Run** simulation

button  and **Pause** simulation button  on the Simulink Editor toolbar.

Observe Simulation Results

After simulating a model you can view the simulation results in a Scope window.

- 1 Double-click the Scope block.

The Scope window opens and displays the simulation results. The plot shows a sine wave signal with the resulting cosine wave signal.

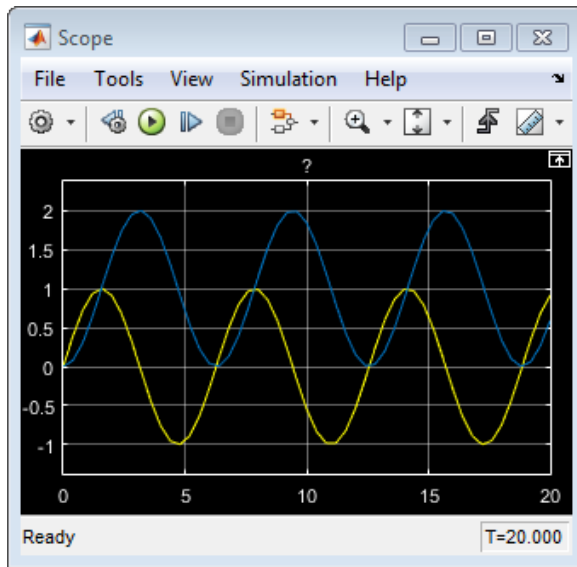

- 2 On the Scope window toolbar, click the **Style** button.



A Style dialog box opens with display options.

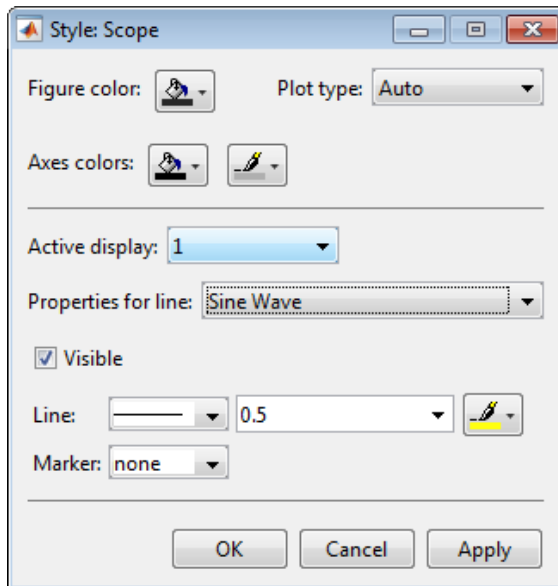

- 3 Change the appearance of the display. For example, select white for the display color and axes background color (icons with a pitcher).
- 4 Select black for the ticks, labels, and grid colors (icon with a paintbrush).
- 5 Change signal line colors for the Sine Wave to blue and the Integrator to red. To see your changes, click **OK** or **Apply**.

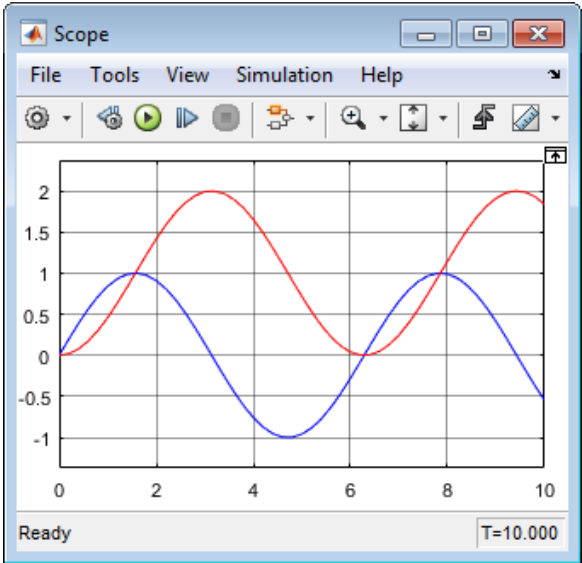

Model a Dynamic System

Model a Dynamic System

This tutorial shows how to model a dynamic system using Simulink software. The completed model is a house heating system that includes a heater (plant), thermostat (controller), and room (environment). Open the Simulink model `matlabroot\help\toolbox\simulink\examples\ex_househeat_modeling` to see the model you will build.

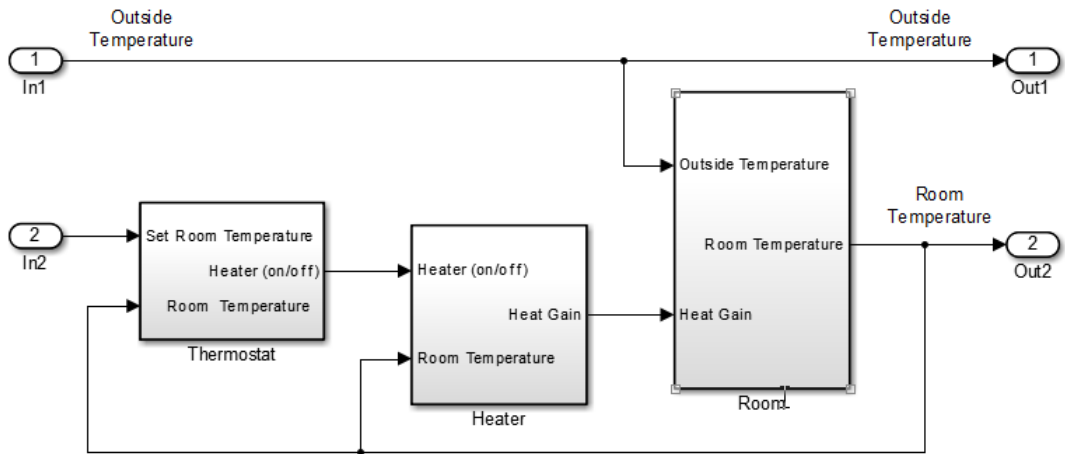

In this section...

“Define a House Heating System” on page 3-2

“Model a House Heating System” on page 3-7

“Integrate a House Heating Model” on page 3-24

Define a House Heating System

Define requirements and mathematical equations. Collect data for model parameters and validating the simulation results.

Determine Modeling Goals

Before designing a model, consider your goals and requirements. The goals for modeling the house heating system are:

- Observe how the changing outdoor temperature affects the indoor temperature.

- Using experimentally measured outdoor and indoor temperatures, compare simulation results with measured values.

Identify System Components

The house heating system in this tutorial defines a heating system and its relationship to a room. It includes:

- Thermal characteristics of a house
- Thermal characteristics of a heater
- A thermostat to control the heater
- Outdoor environment
- Indoor environment

After you select a thermostat setting, the thermostat turns the heater on and off depending on the difference between the outside temperature and the room temperature.

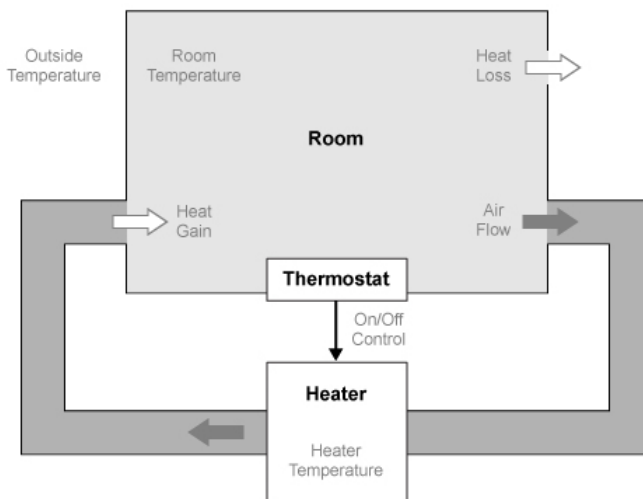

The model for this system includes three components: heater, thermostat, and room.

Define System Equations

Three variables define the house heating model:

- Thermal energy transferred from the heater (Q_{gain}) to a room

- Thermal energy transferred from the room (Q_{loss}) to the outdoor environment
- Temperature of the room (T_{room})

A differential equation defines each of the variables, but since heat transfer is defined in terms of changing temperature, only room temperature is a state variable.

Rate of Heat Gain Equation

The temperature of the air in the heater is T_{heater} and the room temperature is T_{room} . Thermal energy gain to the room is by convection of heated air from the heater. Heat gain for a mass of air in the heater $m_{heaterair}$ is

$$Q_{gain} = m_{heaterair} c_{air} (T_{heater} - T_{room}).$$

A fan takes room air, and passes it through the heater and back to the room. The rate of thermal energy gain from the heater is

$$\frac{dQ_{gain}}{dt} = \frac{dm_{heaterair}}{dt} c_{air} (T_{heater} - T_{room}).$$

Since the mass of air per unit time from the heater is constant, replace $dm_{heaterair} / dt$ with a constant $M_{heaterair}$ and simplify the equation to

$$\frac{dQ_{gain}}{dt} = M_{heaterair} c_{air} (T_{heater} - T_{room}).$$

Rate of Heat Loss Equation

Thermal energy loss from the room is by conduction through the walls and windows:

$$Q_{loss} = \frac{kA(T_{room} - T_{outside})t}{D}.$$

The rate of thermal energy loss is

$$\frac{dQ_{loss}}{dt} = \frac{kA(T_{room} - T_{outside})}{D}.$$

Replacing kA/D with thermal resistance R simplifies the equation to

$$\frac{dQ_{loss}}{dt} = \frac{(T_{room} - T_{outside})}{R}.$$

Changing Room Temperature Equation

Define the rate of temperature change in the room by subtracting the rate of heat loss from the rate of heat gain:

$$\frac{dT_{room}}{dt} = \frac{1}{m_{roomair} c_{air}} \left(\frac{dQ_{gain}}{dt} - \frac{dQ_{loss}}{dt} \right)$$

Collect Data

Most of the parameter values needed for the house heating model are published in standard property tables. The flow rate for the heater is from a manufacturer data sheet.

List the variables and coefficients from your equations and check for dimensional consistency between the units. Since the unit of time for the model is hours, convert published values for the thermal property of materials from units of seconds to hours.

Equation Variables and Constants

You can use the constant names and values in this table when building the model.

Equation Variable or Coefficient	Description	Units
A	Area of wall or window surface $A_{wall} = 914, A_{window} = 6$	square meter
D	Depth of wall or window $D_{wall} = 0.2, D_{window} = 0.01$	meter
Q	Thermal energy transferred	joule
dQ/dt	Rate of thermal energy transferred	joule/hour

Equation Variable or Coefficient	Description	Units
k	Thermal conductivity; property of a material to conduct heat transfer $k_{\text{fiberglass}} = 136.8,$ $k_{\text{glass}} = 2808$	joule/meter · hour · degree
r	Thermal resistivity; property of a material to resist heat transfer $r = 1/k$	meter · hour · degree/joule
R	Thermal resistance $R = D/kA = (T_1 - T_2)Q$ $R_{\text{wall}} = 1.599\text{e-}6, R_{\text{window}} = 5.935\text{-}7$ $R_{\text{equivalent}} = (R_{\text{wall}} * R_{\text{window}}) / (R_{\text{wall}} + R_{\text{window}}) = 4.329\text{e-}7$	hour · degree/joule
m	Mass of air in the room or heater $m_{\text{room_air}} = 1470$ The mass of the heater $m_{\text{heater_air}}$ is not needed for this model.	kilogram
dm/dt	Rate of air mass passing through the heater	kilogram/hour
M	Constant rate of air mass passing through the heater $M_{\text{heater_air}} = 3600$	kilogram/hour

Equation Variable or Coefficient	Description	Units
c	Specific heat capacity $c_{\text{air}} = 1005.4$	joule/kilogram · degree
T_{heater}	Constant air temperature from heater $T_{\text{heater}} = 50$	degree Celsius
T_{room}	Air temperature of room Initial air temperature of room $T_{\text{roomIC}} = 20$	degree Celsius

Model a House Heating System

Model the top-level structure and individual components. Organize your model into a hierarchical structure that corresponds to the components of the system.

Model Top-Level Structure

At the top level of the house heating model, use Subsystem blocks to organize your model and create the structure. The model includes the subsystems Thermostat, Heater, and Room.

- 1 Open the Simulink Library Browser. At the MATLAB command prompt, enter:
`simulink`
- 2 Create a Simulink model. On the Library Browser toolbar, click the **New Model** button .
- 3 Add Subsystem blocks. Drag three Subsystem blocks from the Ports & Subsystems library to the new model in the Simulink Editor.

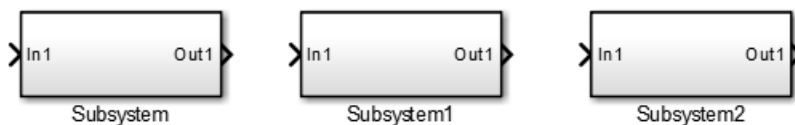

- 4 Open a Subsystem block. Double-click the block.

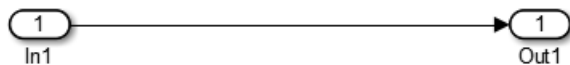

Each new Subsystem block contains one Inport (In1) and one Outport (Out1) block. These blocks define the subsystem interface with the next higher level in a model hierarchy.

Each Inport block creates an input port on the Subsystem block, and each Outport block creates an output port. Add more blocks for additional input and output signals.

- 5 On the Simulink Editor toolbar, click the **Up to Parent** button  to return to the top level. Rename the Subsystem blocks as shown. Double-click a block name and type the new name.

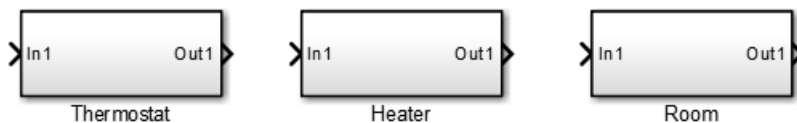

Model Heater Component

The heater component:

- Takes the current temperature from the room and a control signal from the thermostat as inputs
- Calculates the heat gain from the heater
- Outputs the heat gain when the room temperature is lower than the selected room temperature

To model the heater subsystem, model the “Rate of Heat Gain Equation” on page 3-4 with Simulink blocks:

$$\frac{dQ_{gain}}{dt} = M_{heaterair} c_{air} (T_{heater} - T_{room}).$$

Subtract Room Air Temperature from Heater Air Temperature

The temperature difference is the current room temperature subtracted from the constant temperature of the heater (T_{heater}). See “Equation Variables and Constants” on page 3-5.

- 1 Open the Heater subsystem block.
- 2 In the Heater subsystem, type Sum to display a list of blocks with Sum in the name. Double-click the Sum block on the list. When prompted for a list of signs, type | - + to place - and + input ports on the block, and press **Enter**.
- 3 Add a Constant block to model the constant air temperature from the heater. Set the block **Constant value** parameter to T_{heater} . You will define the value of T_{heater} in the Model Workspace.
- 4 Add an Inport block to connect the room temperature signal to another part of your model.
- 5 Rename the blocks and connect them as shown in the figure.

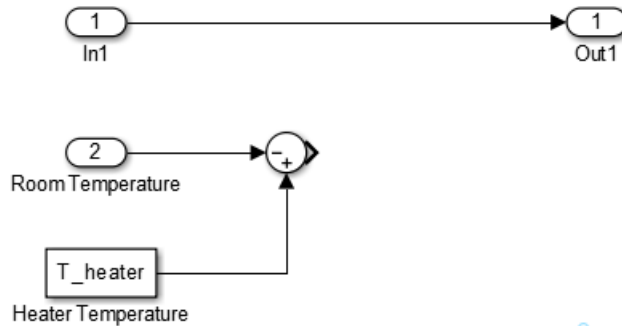

- 6 Add labels to the signal lines to help trace model components to the equations and model requirements. Double-click above a signal line and enter a label.

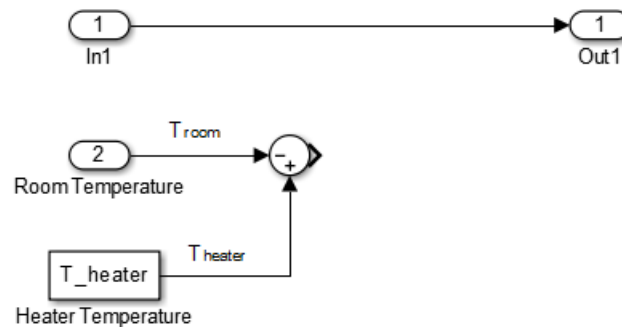

Multiply Temperature Difference by Heat Gain Per Degree

The heat gain per degree is the constant rate of mass from the heater (M_heater_air) multiplied by the specific heat capacity of air (c_air). See “Equation Variables and Constants” on page 3-5.

- 1 Add a Gain block to the Heater subsystem. Set the **Gain** parameter to $M_heater_air*c_air$. You will define the values of these variables in the Model Workspace.
- 2 Connect the output of the Sum block to the input of the Gain block.
- 3 Rename the Gain block to Heat Gain/Degree.

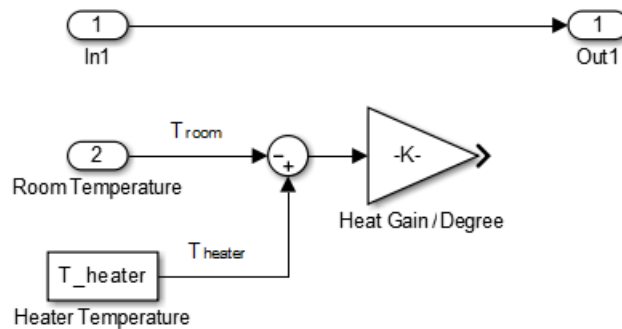

Model a Heater Switch

The thermostat sends an on/off signal equal to 1 (on) or 0 (off) to the heater. Because the input signal is binary, you can use a Multiplier block to model a switch.

- 1 Remove the connection between the In1 and Out1 blocks. Select the line and press **Delete**.
- 2 Add a Product block. Resize the block vertically to align the block in your diagram. Connect the In1 block to the first block input and the block output to the Out1 block. Rename the blocks as shown.



- 3 Connect the output from the Gain block to the second input. Move all the connected blocks together. Draw a selection box around the blocks you want to move, and then drag them to the new location.
- 4 Rename blocks and add labels to signals as shown in the figure.

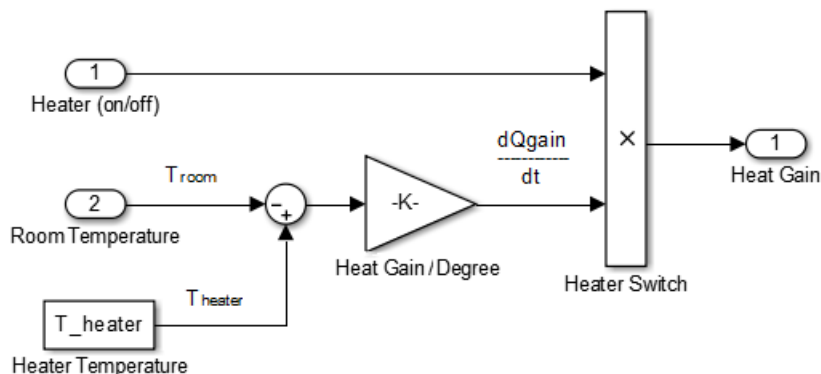

The Inport and Outport blocks create ports that connect this subsystem to other subsystems in your model.

Define Model Parameters

You can define variables in the MATLAB Workspace and then enter their names in the block parameter dialog boxes. However, a more robust method is to use the Simulink Model Workspace because variable values are saved with the model.

- 1 In the Simulink Editor, select **View > Model Explorer > Model Workspace**.

- In Model Explorer, select **Add > MATLAB Variable**. In the middle pane, click the new variable **Var** and enter the variable name for a block parameter. For this example, enter **T_heater**.

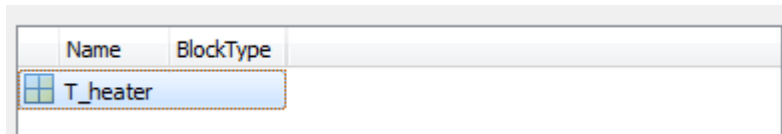

- In the right pane, in the **Value** box, enter the value of the variable. For this example, enter **50** degrees. Click **Apply**.

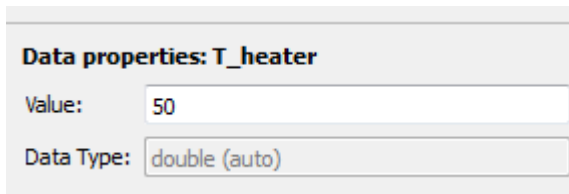

- Using the same approach, add the variable **M_heater_air** with a value of **3600** kilogram/hour and **c_air** with a value of **1005.4** joule/kilogram · degree.

Prepare Model for Simulation

Set up the heater model for simulation. Think about the expected behavior and how you can test that behavior with a simulation. When the thermostat output is 1, the expected output from the gain is $(50 - 25) \times 3600 \times 1005.3 = 9.05 \times 10^7$.

- From the Heater subsystem, click the **Up to Parent** button  to navigate to the top level of your model. You can resize the Heater block as shown in the figure.

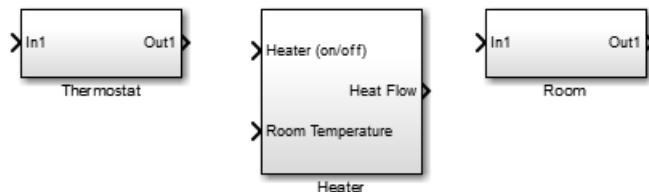

Notice the Heater block has a second input port and that each port corresponds to an Import block or Outputport block in the subsystem.

- 2 Add a Constant block to represent the room temperature, and set the value to 25 (degrees Celsius). Add a Step block for a temporary Heater (on/off) signal. Set **Step time** to 4.
- 3 Add a Scope block and connect it to the Heat Flow output. Connect the rest of the blocks as shown.

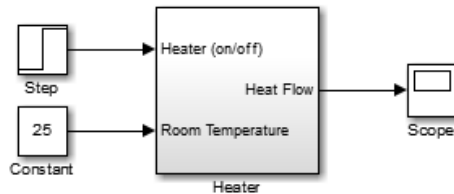

Simulate Model and Evaluate Results

Use the default simulation settings to validate your model design.

- 1 Open the Configuration Parameters dialog box. In the Simulink Editor, select **Simulation > Model Configuration Parameters**.

Verify that **Stop time** is set to 10, **Type** to **Variable-step**, and **Solver** to **ode45**.

- 2 Double-click the Scope block to open it.
- 3 Simulate the model. Select **Simulation > Run**, or click the **Run** button .

As the simulation runs, the Scope plots the results.

- 4 View the scope trace. Right-click the y-axis and select **Axes properties**. Set **Y-min** to $-2e7$ and **Y-max** to $12e7$.

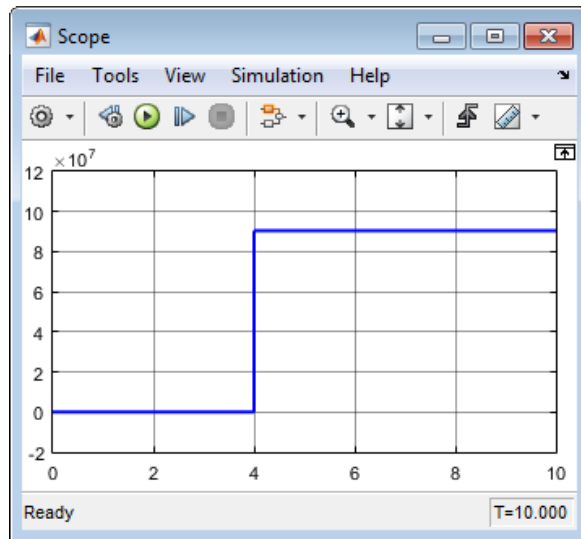

- 5 Determine if this result is what you expected.

When the heater on/off signal flips from 0 to 1 at 4 hours, the heater outputs 9.05×10^7 joule/hour. The simulation validates the expected behavior.

Model Thermostat Component

You can model a thermostat without using system equations. Requirements for this component:

- When the room temperature is below the set temperature, the control signal equals 1. When the room temperature is above the set temperature, the control signal equals 0.
- There is a hysteresis of 2 degrees Celsius around the temperature set point. If the thermostat is on, the room temperature must increase 2 degrees above the set temperature before turning off.

This component models the operation of a thermostat, determining when the heating system is on or off. It contains only one Relay block but logically represents the thermostat in the model.

Subtract Set Room Temperature from Room Temperature

If the set room temperature is warmer than the room temperature, the thermostat model sends an “on” signal to the heater model. To determine if this is the case, begin by subtracting the room temperature from the set temperature.

- 1 Open the Thermostat subsystem. Add a Sum block to it. Set the **List of signs** parameter to $|+-$ to place + and – input ports on the block.
- 2 Connect the Inport block to the + input of the Sum block. The Inport block sets the room temperature.
- 3 Add a second Inport block and connect it to the – input of the Sum block. This second Inport block is the current room temperature from the room subsystem. Move the output port to the top of the block. Right-click the block and select **Rotate & Flip > Counterclockwise**. If you want, you can reshape the block as shown in the figure by dragging the handles.
- 4 Rename the blocks as shown.

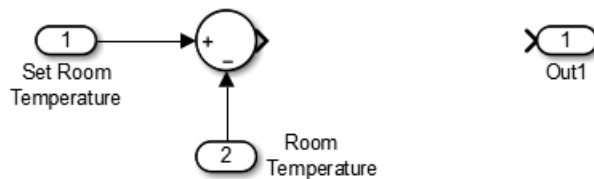

Model Thermostat Signal

Model the signal from the thermostat with a hysteresis value of 2 s Celsius.

- 1 In the Thermostat subsystem, add a Relay block. Set the **Switch on point** parameter to 2, and the **Switch off point** parameter to -2.
- 2 Connect and rename the blocks as shown in the figure.

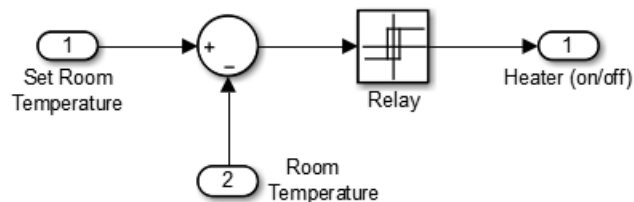

Prepare Model for Simulation

Prepare the Thermostat subsystem for simulation. Think about the expected behavior of the thermostat and how you can test that behavior with a simulation. When the room temperature rises above the thermostat setting by 2 degrees, the thermostat output is 0. When the room temperature moves below the thermostat setting by 2 degrees, the thermostat output is 1.

- 1 From the Thermostat subsystem, click the **Up to Parent** button  to navigate to the top level of your model. Resize the Thermostat block as shown in the figure.

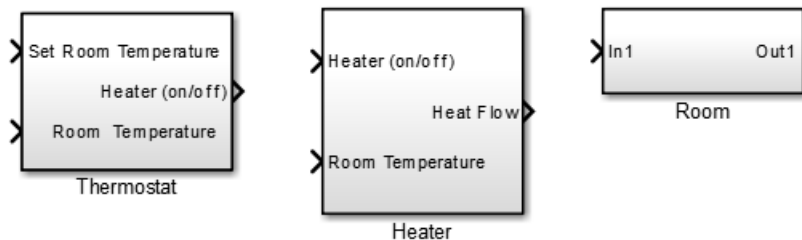

Notice the Thermostat subsystem now has a second input port. Each input port corresponds to an Inport block in the subsystem.

- 2 Add a Constant block for setting the room temperature. Set the **Constant** parameter to 25 (degrees Celsius).
- 3 Add a Sine Wave block to represent the changing room temperature. Set the **Bias** parameter to 20 and the **Amplitude** parameter to 10. These parameters give a variation above and below the temperature set point of 25.
- 4 Add a Floating Scope block. Set the parameters **Amplitude** to 10, **Bias** to 20, and **Frequency** to 0.5. These settings show the model behavior as outside temperature increases above and below the set temperature of 25.
- 5 Connect the blocks as show in the figure.

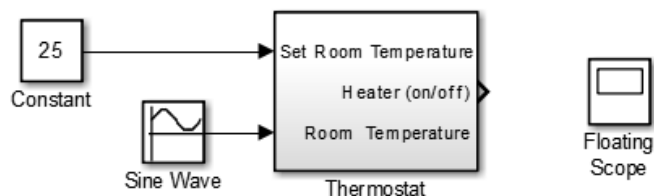

- 6 Double-click the Floating Scope. From the toolbar, click the **Signal Selection** button .
- 7 In the Signal Selector dialog box, select the **Constant**, **Sine Wave**, and **Thermostat** check boxes, and then click **Close**.

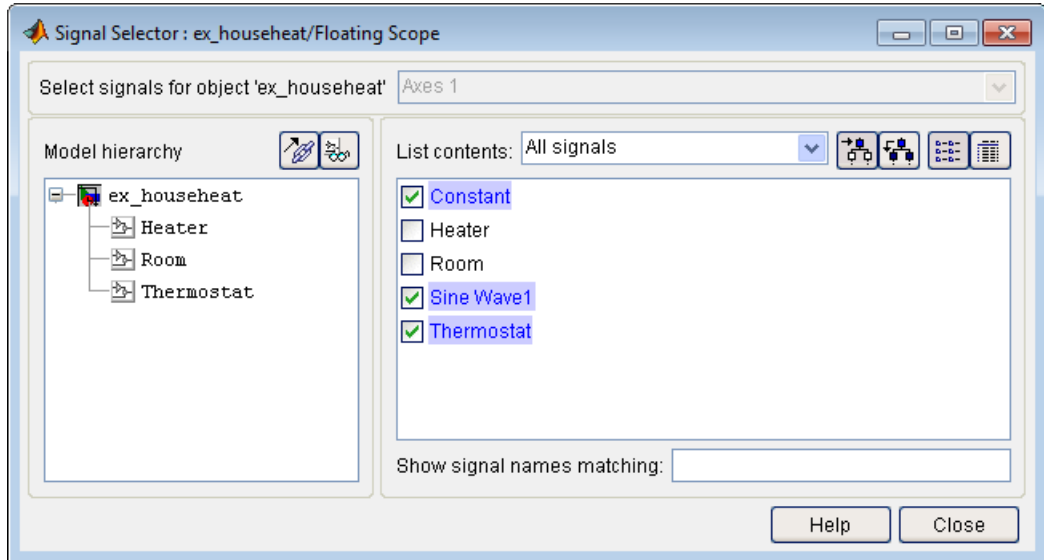

Simulate Model and Evaluate Results

Use the default simulation settings to validate your model design.

- 1 In the Model Configuration Parameters dialog box, verify that **Stop time** is set to 10, **Type** to **Variable-step**, and **Solver** to **ode45**.
- 2 Simulate the model. As the simulation runs, the Floating Scope plots the results.
- 3 Open the Floating Scope to view the scope trace. Right-click the y-axis and select **Axes properties**. Set **Y-min** to -2 and **Y-max** to 35.

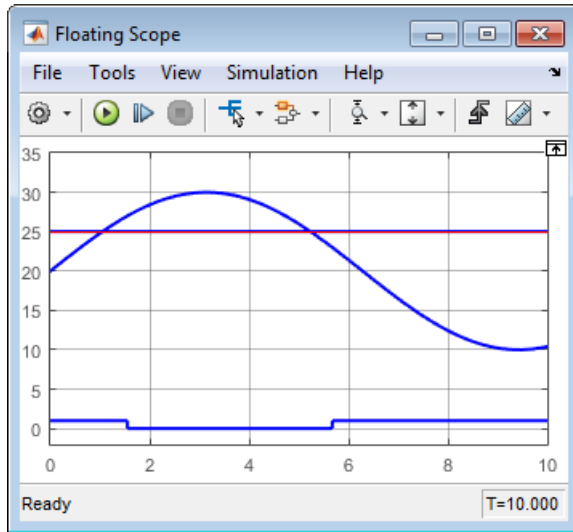

- 4 Determine if this result is what you expected.

Initially the relay is on, and the room temperature is below the set temperature. When the room temperature increases above the set temperature, the relay does not initially switch to 0 until the room temperature increases by 2 more degrees. Simulation validates the expected behavior.

Model Room Component

Inputs to the room component are heat flow from the heater component and the external air temperature. The room component uses these inputs to compute heat loss through the walls, heat loss through the windows, and the current room temperature.

To design the room subsystem, use the “Rate of Heat Loss Equation” on page 3-4 and the “Changing Room Temperature Equation” on page 3-5.

Model Changing Room Temperature

The rate of temperature change in the room (dT_{room}/dt) is defined by the equation

$$\frac{dT_{room}}{dt} = \frac{1}{m_{roomair} c_{air}} \left(\frac{dQ_{gain}}{dt} - \frac{dQ_{loss}}{dt} \right)$$

The term dQ_{gain}/dt is a signal from the Heater subsystem.

- 1 Open the Room subsystem block. In the Room subsystem, add a Sum block. Set the **List of signs** parameter to |+-.
- 2 Connect In1 to the + input. The input is the heat gain (dQ_{gain}/dt) from the heater component. The - input connects to the heat loss (dQ_{loss}/dt) from the room.
- 3 Add a Gain block. Set the **Gain** parameter to $1/(m_{\text{room_air}}*c_{\text{air}})$. Connect the output of the Sum block to the input of the Gain block. Label signals as shown in the figure. Dotted signal lines are signals you will connect later.

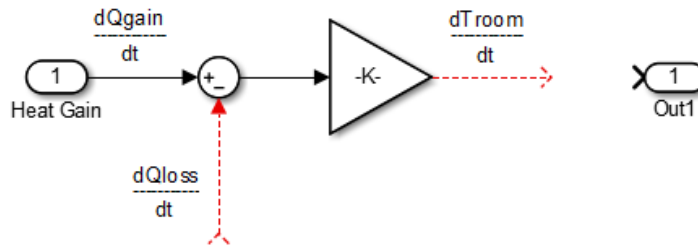

Model Room Temperature

The output of the Gain block is the change in room temperature (dT_{room}/dt). To get the current room temperature (T_{room}), integrate the signal.

- 1 Add an Integrator block. Set the **Initial condition** parameter to T_{roomIC} .
- 2 Connect the output of the Integrator block to Out1 as shown.

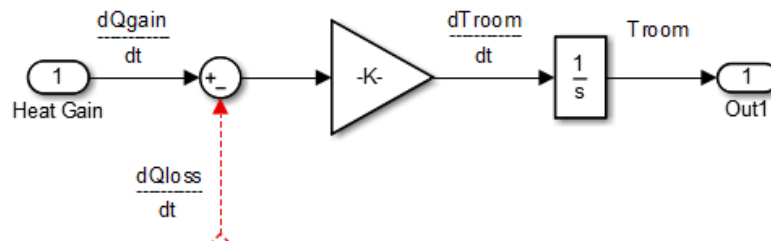

Model Heat Loss Through Walls and Windows

This equation is the rate of thermal energy loss through the walls and windows:

$$\frac{dQ_{loss}}{dt} = \frac{(T_{room} - T_{outside})}{R}$$

- 1 In the Room subsystem, add a Sum block. Set the **List of signs** parameter to |+-|. Right-click the block and select **Rotate & Flip > Flip Block**.
- 2 Click the signal line for T_{room}, press **Ctrl**, and then click and drag a branch signal line. Connect the line to the + input on the Sum block.
- 3 Add another Inport block and connect it to the - input of the Sum block. Rename it to Outside Temperature.
- 4 Add another Gain block. Set the **Gain** parameter to 1/R_{equivalent}. Right-click the block and select **Rotate & Flip > Flip Block**.
- 5 Connect the blocks as shown in the figure.

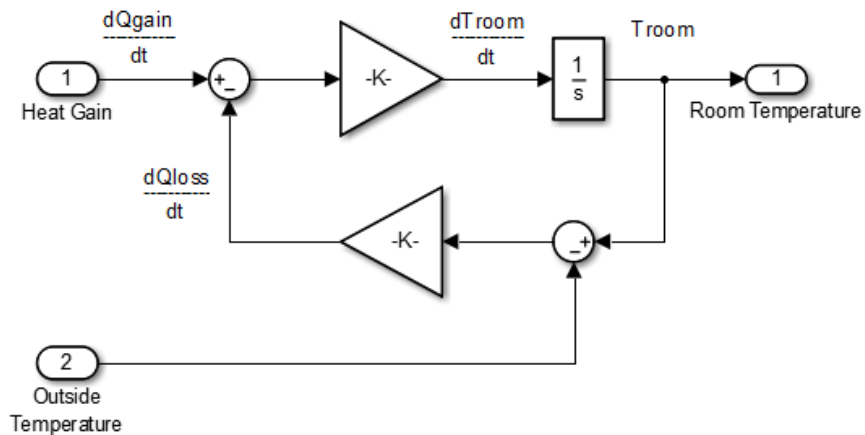

Define Model Parameters

You can define parameters in the MATLAB Workspace and then enter their names in the block parameter dialog boxes. However, a more robust method is to use the Simulink Model Workspace, which saves parameter values.

- 1 In the Simulink Editor, select **View > Model Explorer > Model Workspace**.
- 2 In the Model Explorer, select **Add > MATLAB Variable**.
- 3 In the middle pane, click the new variable **Var** and enter the name `m_room_air`. In the right pane, enter the value 1470 (kilograms).

- 4 Add the variables $T_{\text{roomIC}} = 20$ (degrees Celsius) and $R_{\text{equivalent}} = 4.329e-7$ (hour · degree/joule).
- 5 Click **Apply**.

Prepare Model for Simulation

Prepare the Room subsystem for simulation. Think about the expected behavior and how you can test that behavior with a simulation. When the heater is off (Heat Gain = 0) and the initial temperature of the room (20) is below the outside temperature (10), heat loss should continue until the room temperature is equal to the outside temperature.

- 1 From the Room subsystem, click the **Up to Parent** button  to navigate to the top level of your model. Resize the Room block as shown in the figure.

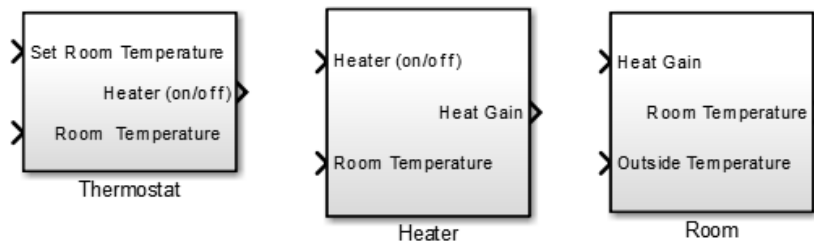

The Room block now has a second input port. Each inport port corresponds to an Inport block in the subsystem.

- 2 Add a Constant block and connect it to the Heat Gain input. Set the **Constant value** parameter to 0 (degrees Celsius) to mean that the heater is turned off.
- 3 Add another Constant block and connect it to the Outside Temperature input. Set the **Constant value** parameter to 10 (degrees Celsius).
- 4 Add and connect a Scope block to view the changing room temperature.

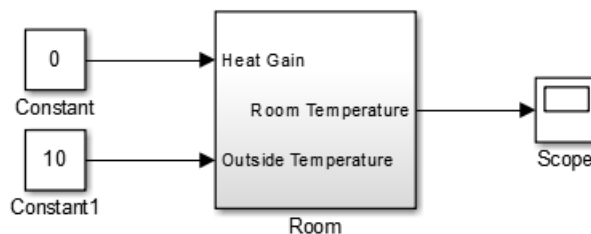

Simulate Model and Evaluate Results

- 1 In the toolbar, set the **Simulation stop time** to 20.
- 2 Simulate the model.
- 3 Open the Scope and click the **Autoscale** button  to view the scope trace.

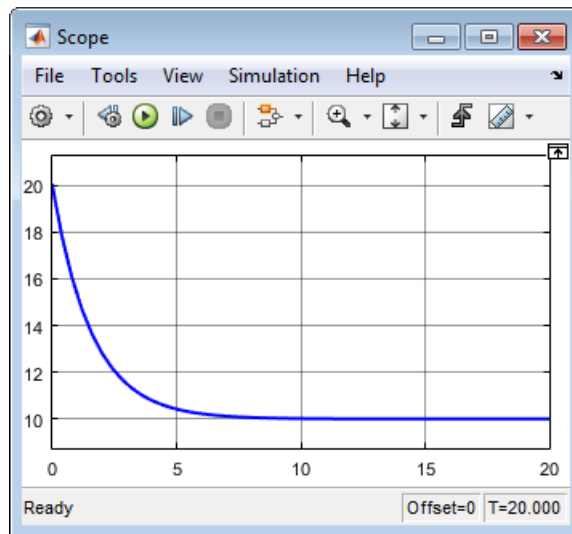

- 4 Determine if this result is what you expected.

The room temperature starts at the initial room temperature set in the Integrator block. Because the heat gain is 0, the signal decays to the outside temperature (10). The simulation validates the expected behavior.

Prepare Model for Second Simulation

Set the constant outside temperature to a value above the initial room temperature (20).

- 1 In the Constant block that is connected to the Outside Temperature input, set **Constant value** to 30 (degrees Celsius).

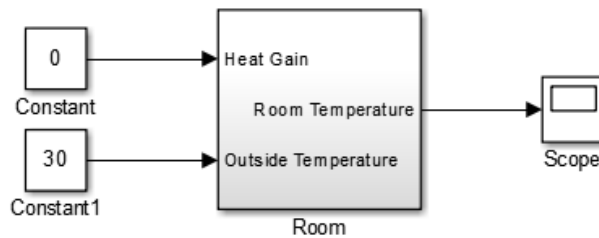

Simulate Model and Evaluate Results

- 1 Simulate the model.
- 2 Open the Scope and click the **Autoscale** button  to view the scope trace.

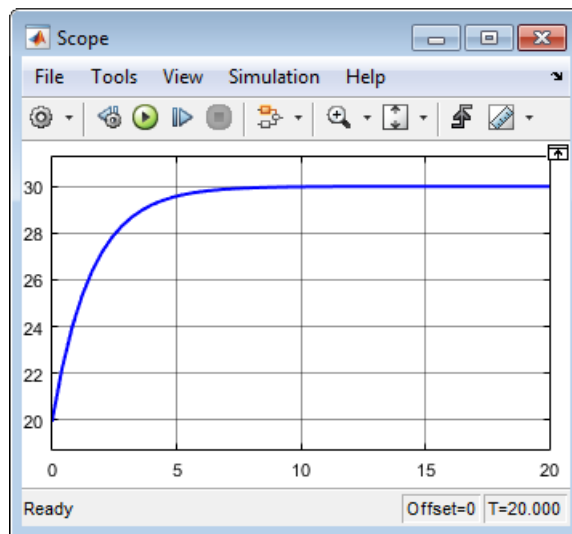

- 3 Determine if this result is what you expected.

Room temperature starts at the initially set temperature of 20, but with the heater off (heat gain = 0) the room temperature rises to the outside temperature.

This result was unexpected because you didn't explicitly model this behavior. However, the equation that models the heat loss also models the heat gain when the outside temperature is above the inside room temperature.

Integrate a House Heating Model

Connect model components, add realistic input, and then simulate the model behavior over time to validate the design.

Integrate Heater and Thermostat Components

To simulate the heater and thermostat subsystems without the Room subsystem, you need a signal for the changing room temperature. Use a Constant block to set the thermostat temperature and a Sine Wave block for a realistic outside temperature signal.

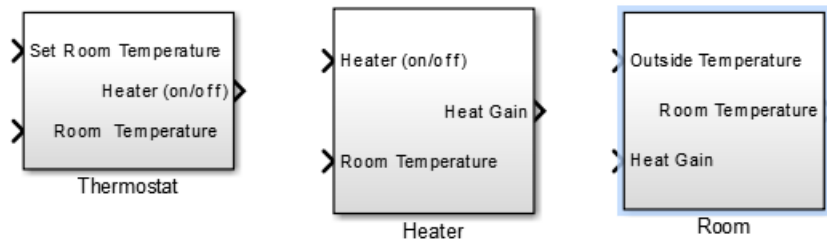

Prepare Model for Simulation

- 1 Open your model with the completed subsystems. Remove any blocks you added to test the separate components.

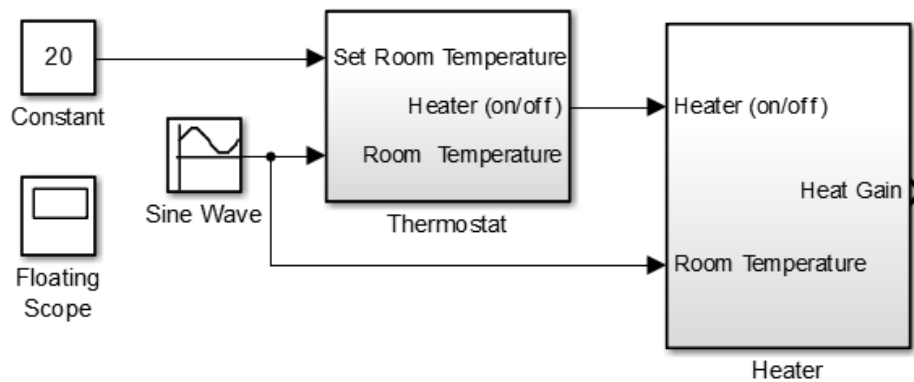

- 2 Connect the Heater (on/off) signal from the Thermostat subsystem output to the Heater subsystem input.
- 3 Add a Constant block to set the thermostat room temperature. Set **Constant** value to 20 (degrees Celsius).
- 4 Add a Sine Wave block to represent the changing room temperature. Set the parameters **Amplitude** to 10 (degrees Celsius), **Bias** to 15, and **Frequency** to 0.5.
- 5 Add a Floating Scope block and connect the blocks as shown in the figure.



- 6 Open the Floating Scope block. From the toolbar, click the **Signal Selector** button .
- 7 In the Signal Selector dialog box, select the **Heater** check box.
- 8 Click the **Parameters** button . On the **General** tab and in the **Number of axes** box, enter 2. A second empty graph appears below the first.
- 9 Click the second graph, and then click the **Signal Selector** button . In the Signal Selector dialog box, select the **Constant** and **Sine Wave** check boxes.
- 10 In the Floating Scope, right-click the bottom graph and select **Axes properties**. Set **Y-min** to 0 and **Y-max** to 35.

Simulate Model and Evaluate Results

Simulate the model using the default stop time of 10 and the default solver ode45.

- 1 Simulate the model.
- 2 Open the Floating Scope and view the simulation results.

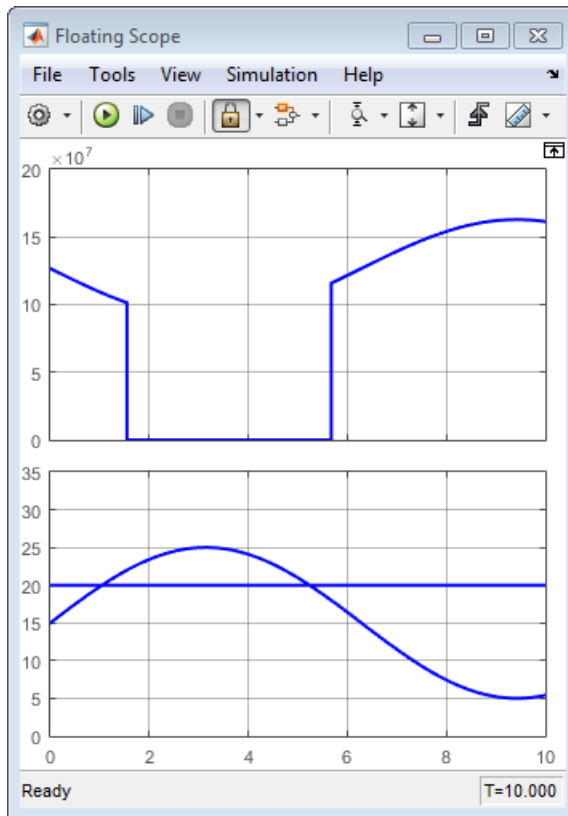

- 3 Determine if this result is what you expected.

From about 0 to 1.5 hours, the heater is turned on. Heat gain is not constant but changes because heat gain is a function of the difference between the heater air temperature and the room air temperature. From 1.5 to 5.6 hours, the heater is turned off and the heat gain (top graph) is zero. The simulation confirms the expected behavior.

Integrate Room Component

To simulate the Heater and Thermostat subsystems with the Room subsystem, you need a signal for the changing outside temperature. Simulating the model allows you to observe how the thermostat setting and outdoor temperature affect the indoor temperature.

Prepare Model for Simulation

- 1 Open your model with completed subsystems. Remove any blocks you added to test the separate components.

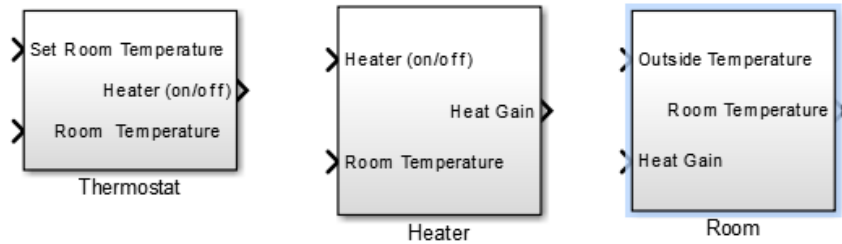

- 2 Connect the subsystems as shown.

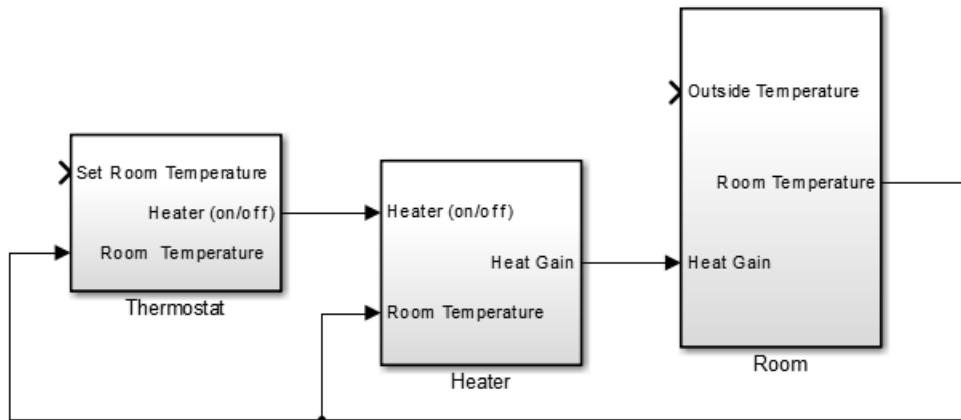

- 3 Add a Constant block for setting the room temperature. Set **Constant value** parameter to 20 (degrees Celsius).
- 4 Add a Sine Wave block to represent the changing outside temperature. Set **Bias** to 12, **Amplitude** to 5, **Frequency** to $2\pi/24$, and **Phase** to 180.
- 5 Add a Floating Scope block to view simulation results.

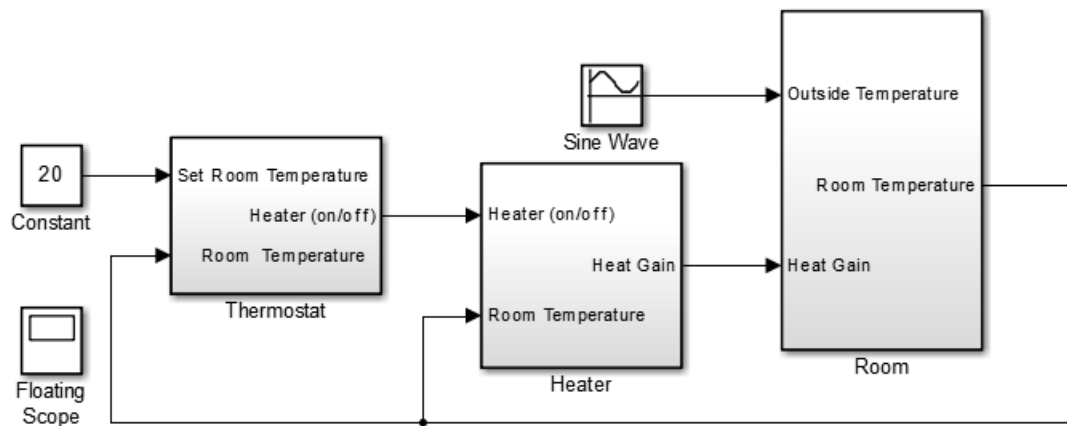

- 6 In the Floating Scope, click the **Signal Selector** button . In the Signal Selector dialog box, select the Room (room temperature) and Sine Wave (outside temperature) signals.
- 7 In the Floating Scope, right-click the graph and select **Axes properties**. Set **Y-min** to 5 and **Y-max** to 25.

Simulate Model and Evaluate Results

- 1 Open the model `matlabroot\help\toolbox\simulink\examples\ex_househeat_modeling_prepared.slx` or use the model you prepared for simulation.
- 2 Set the simulation stop time to 24 (hours) to represent a day.
- 3 Simulate the model.
- 4 Open the Floating Scope and view results.

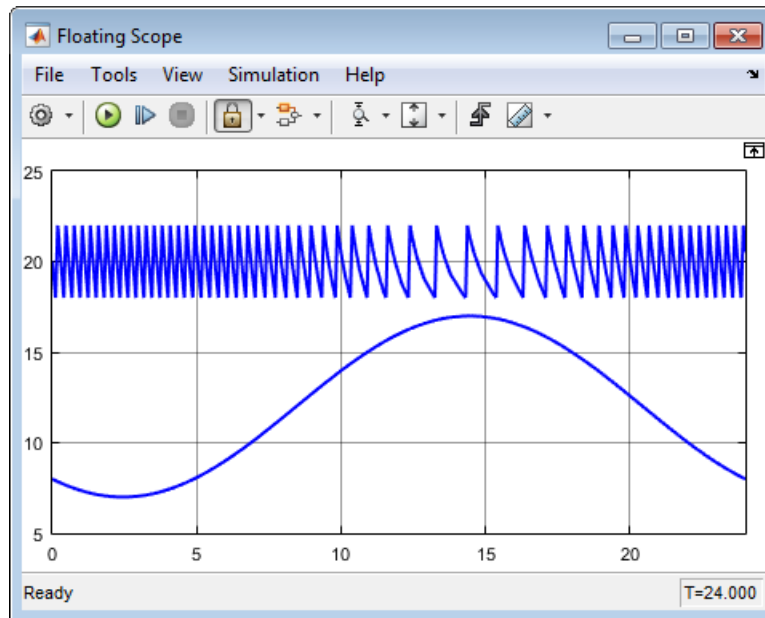

- 5 Determine if the simulation result matches your expectation.

When the outside temperature is below the set room temperature, the room temperature fluctuates 2 degrees above and below the set temperature. Since the thermostat subsystem includes a 2 degree hysteresis, this simulation result is expected.

Refine Model Parameters

With Simulink models, you can interactively change model parameters and then observe changes in the behavior of your model. This approach allows you to evaluate your model quickly and validate your design.

Change the outside temperature in the Sine Wave block so that upper values are above the thermostat temperature.

- 1 In the Sine Wave dialog box, set **Bias** to 19 and **Amplitude** to 5. These settings show what happens when outside temperature is higher than inside temperature.
- 2 Simulate the model and view the results.

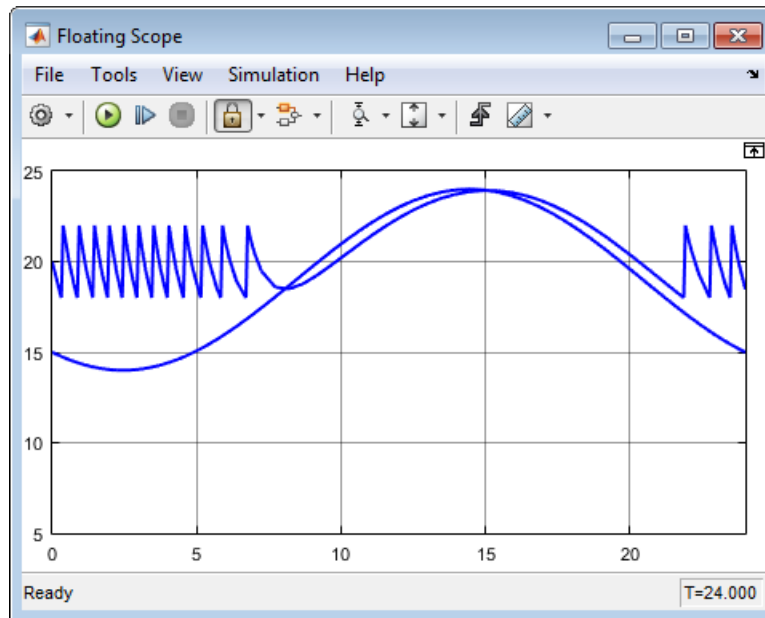

- 3 Determine if the results match your expectations.

When the outside temperature is above the set thermostat temperature, the room temperature is about equal to the outside temperature. In this case, heat loss is a loss of heat from the outside environment into the room.

Model External Interface

Model the external interface for further testing and possible use in a larger model. In Simulink, you model the external interfaces using Inport and Output blocks. For the house heating model, add Inport blocks to read data from the outside temperature and thermostat set temperature into your model. Add Output blocks to connect the outside temperature and room temperature to a larger model or to visualize results.

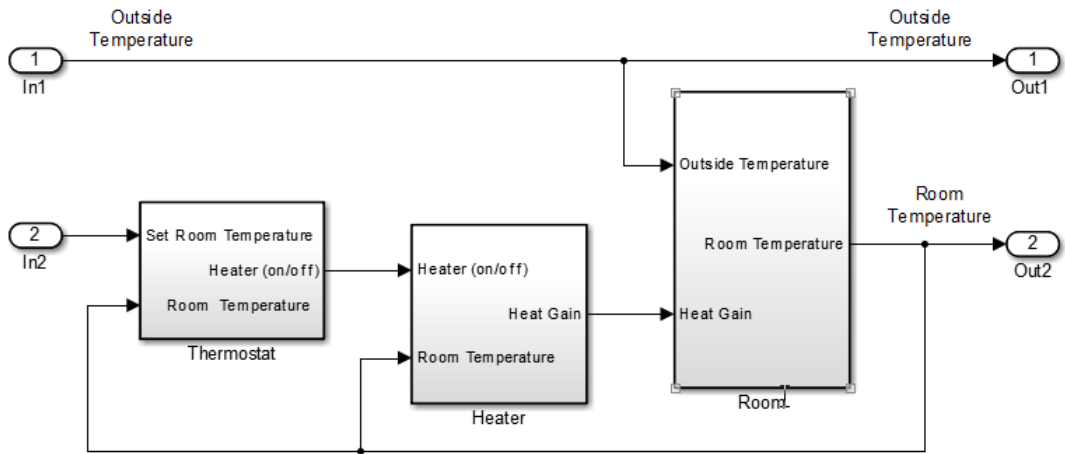

After validating the model design, verify the correctness of the model by comparing simulations with real system data. See “Simulate a Dynamic System” on page 4-2.

Basic Simulation Workflow

Simulate a Dynamic System

This tutorial shows how to simulate the model of a dynamic system using Simulink software, and then use the results to improve the model. The model is a house heating system that includes a heater (plant), thermostat (controller), and room (environment) with interfaces to input measured system data.

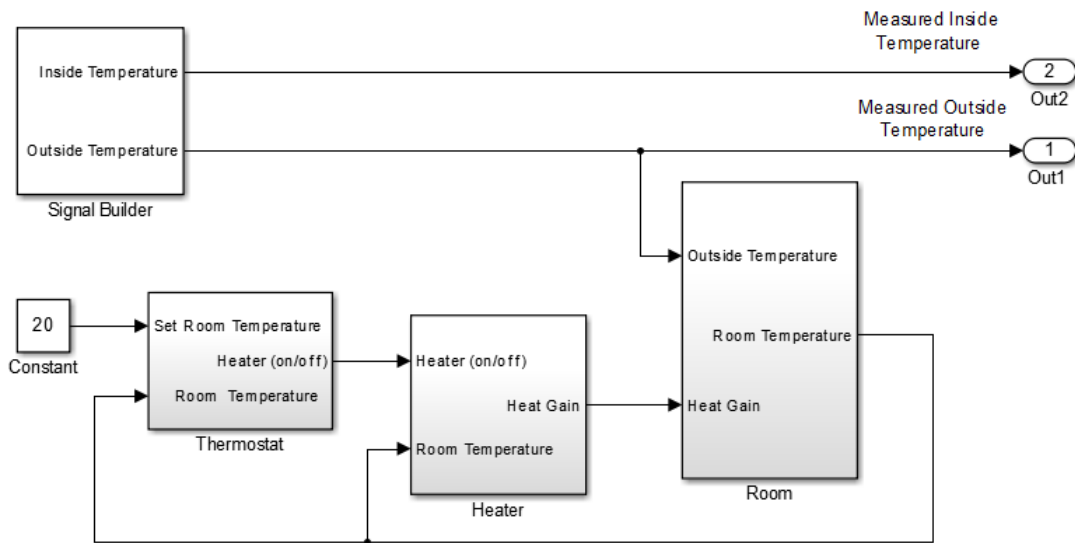

Before preparing a model for simulation, build the model and validate the model design. See “Model a Dynamic System” on page 3-2.

In this section...

“Prepare Simulation” on page 4-2

“Run and Evaluate Simulation” on page 4-5

Prepare Simulation

Add interfaces to input measured data, add control signals, and update model parameters.

Determine Simulation Goals

Before simulating a model, consider your goals and requirements. For the house heating system, these are the goals:

- Verify that the simulation represents the behavior of the modeled system.
- Improve the accuracy of the model by optimizing parameters.

Collect Data

Measure parameters for an actual house heating system. You will use the measured data with model simulations to verify the behavior and accuracy of your model.

- 1 Measure the outside and inside temperatures of a house every 6 minutes for 24 hours.
- 2 Enter the measured data into a Microsoft Excel worksheet. You can open `ex_househeat_measured_data.xls` for an example.

	A	B	C
	Time (hours)	Inside Temperature	Outside Temperature
1	0.00	25.20	6.60
2	0.10	21.00	6.50
3	0.20	20.00	6.60
4	0.30	19.70	6.60
5	0.40	24.60	6.60
6	0.50	25.30	6.40
7	0.60	21.30	6.60
8	0.70	19.80	7.00
9	0.80	22.80	6.70

- 3 Plot the measured data in a chart. The inside temperature data shows temperature spikes when the hot air heater turns on. This pattern is typical for a hot air heating system.

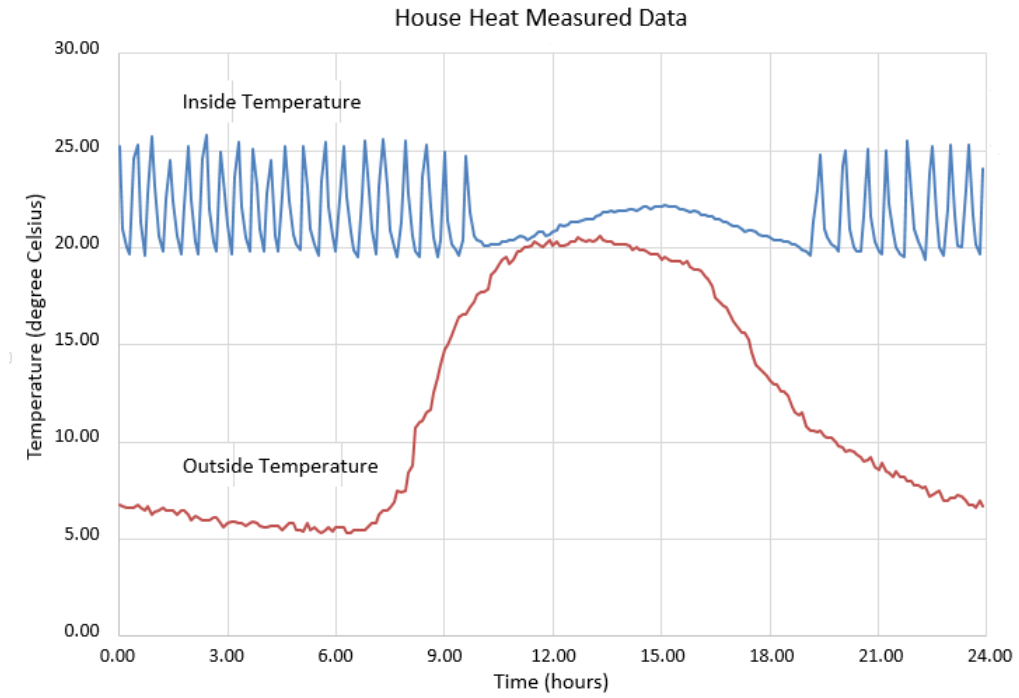

Prepare Model

Prepare a model for simulation by adding external interfaces for data input and adding input control signals.

- 1 Open the model `matlabroot/help/toolbox/simulink/examples/ex_househeat_modeling.slx` or use the model you created in the tutorial “Model a Dynamic System” on page 3-2.
- 2 Replace the In1 block with a Signal Builder block. The Signal Builder block imports data from a Microsoft Excel worksheet.
- 3 Replace the In2 block with a Constant block and set the value to 20. The Constant block sets the thermostat temperature.

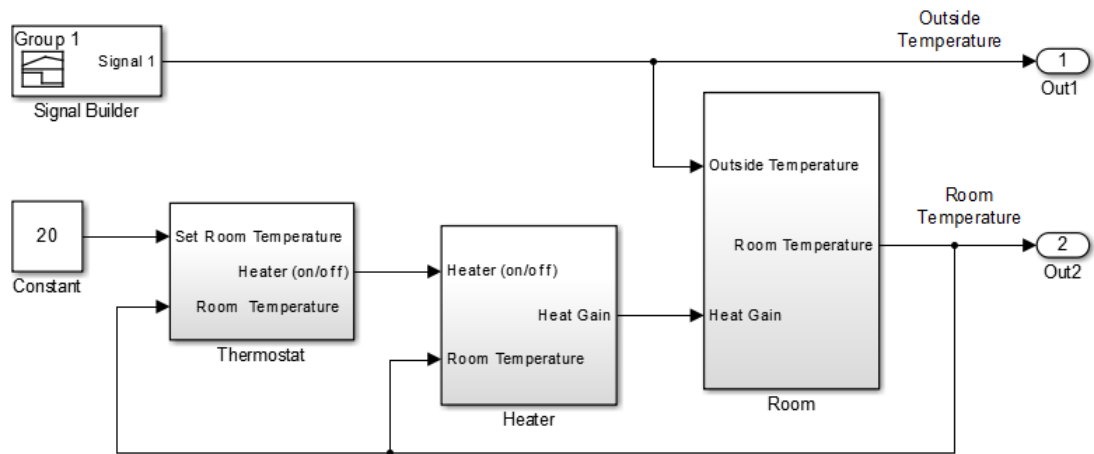

4 Save the model.

Update Model Parameters

For the first time through the basic simulation workflow, use the model parameters saved with the model.

Some parameters to consider for optimization are heater hysteresis, temperature offset, and the resistance of the house to heat loss. The parameter values for modeling and validating the model design were approximated and estimated.

Run and Evaluate Simulation

Define simulation parameters, run simulation, and evaluate simulation results.

Import Data

A Signal Builder block can import data from a Microsoft Excel worksheet into a Simulink model. The imported data is saved with the model. When you close and then open the model, the data is loaded into memory.

- 1 Open the model `matlabroot\help\toolbox\simulink\examples\ex_househeat_simulation_import_data.slx` or use the model you prepared for importing data.

- 2 Double-click the Signal Builder block.
- 3 In the Signal Builder, select **File > Import from File**. Browse to and select the file `matlabroot\help\toolbox\simulink\examples\ex_househeat_measured_data.xls` or use your data file.
- 4 Expand the **Sheet1** node to view the data columns. Select the **Sheet1** check box, which also selects the contents.

The **Data to Import** pane shows:

- Excel file name
- Worksheet in the file
- Columns of data in the worksheet

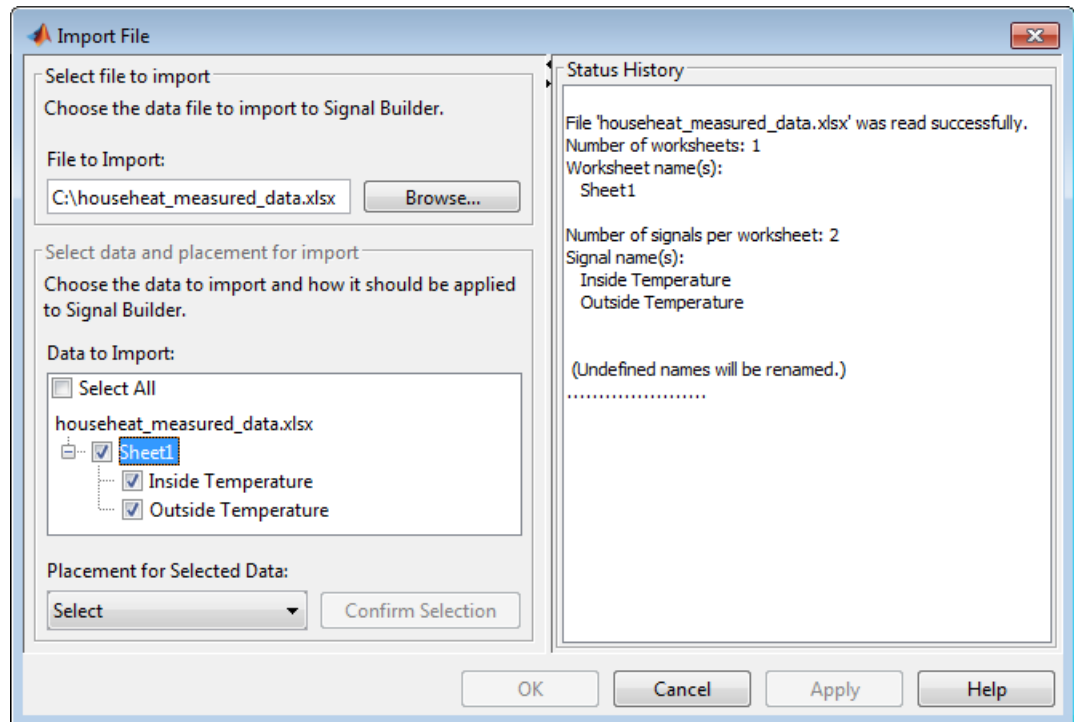

- 5 From the **Placement for Selected Data** list, select **Replace existing dataset**. Click **Confirm Selection**. Click **OK**.
- 6 Respond to the message that appears. Select **No, import without saving**.

- 7 View imported signals in the Signal Builder window. The figure shows the signal group as it appears in the Signal Builder plots.

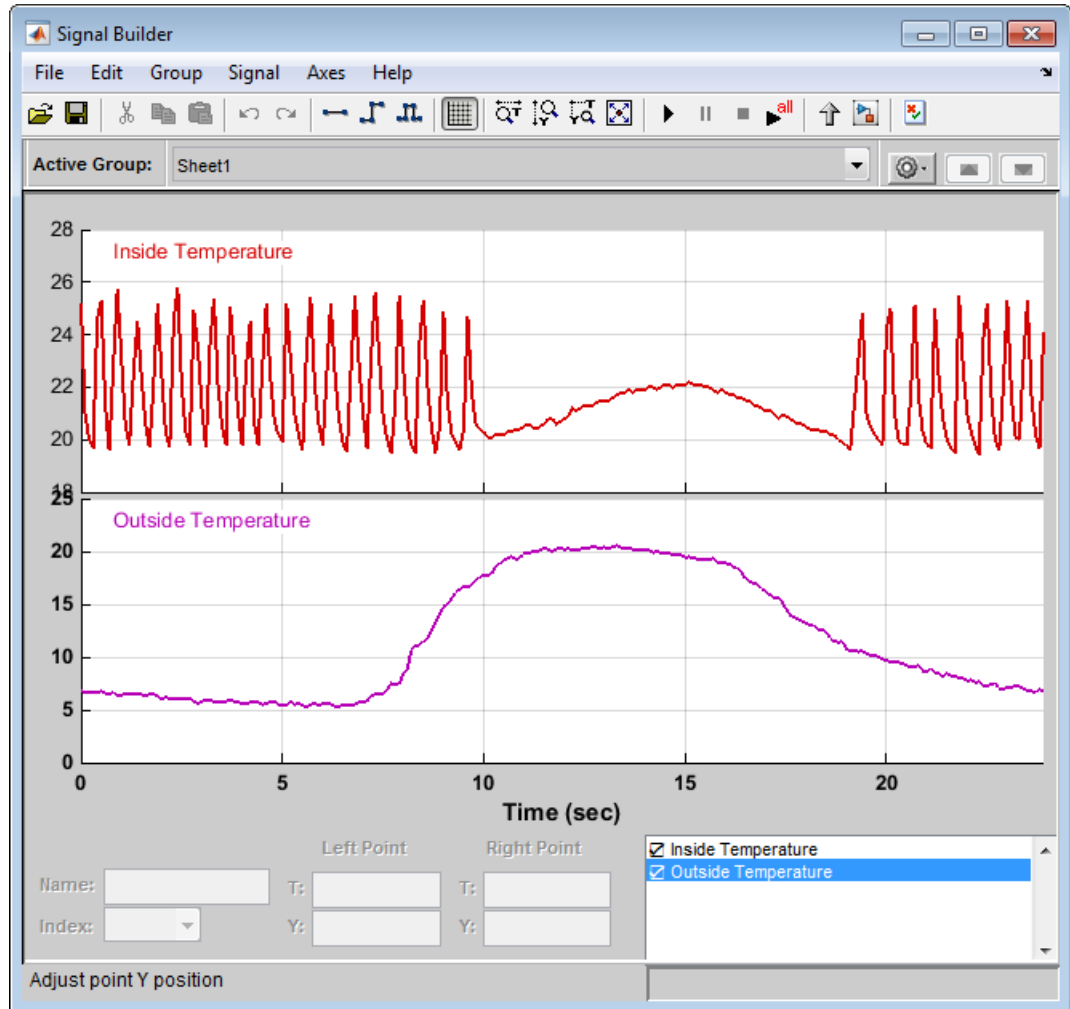

- 8 Select **Group > Rename** and enter a group name. For example, enter Measured Data. Close the Signal Builder.

The Signal Builder block now has two output ports, one for each column of data imported from the worksheet.

- 9 In the model, reconnect the Outside Temperature port from the Signal Builder block to the signal line.
- 10 Add an Outport block above the Out1 block. Connect the Inside Temperature output from the Signal Builder block to this block.

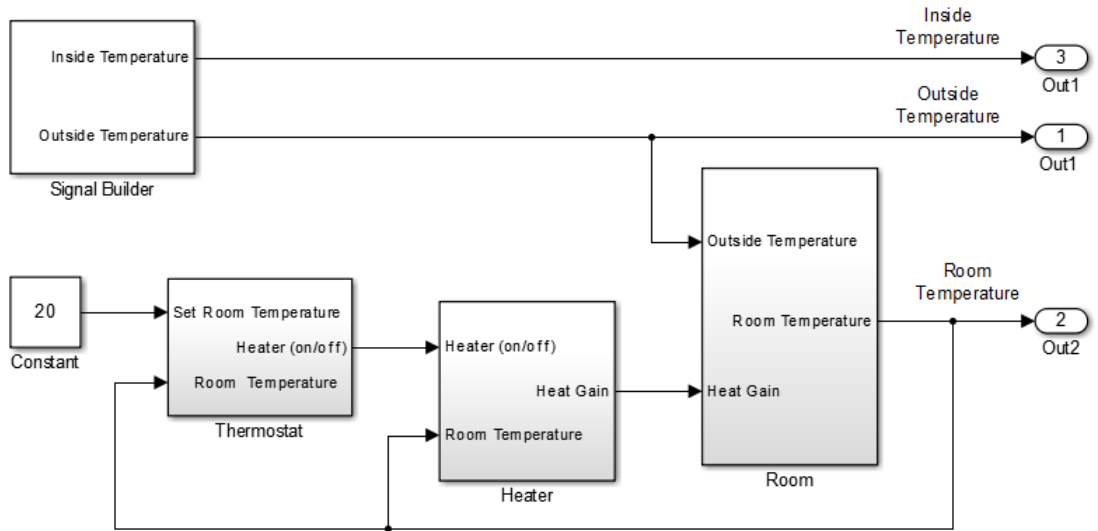

Set Simulation Parameters

Before running a simulation of your model, set simulation parameters. Simulation parameters to consider include the solver type and options for saving (logging) the simulation results.

Configure Model to Save Simulation Results

Configure your model to save (log) signal data during a simulation. You can view logged signals from each simulation using the Simulink Data Inspector.

- 1 In the model, select **Simulation > Model Configuration Parameters**. In the left pane, select **Data Import/Export**.

The data logging parameters appear in the right pane.
- 2 Clear the **Time** and **Output** check boxes.
- 3 Select the **Signal logging** check box and from the **Signal logging format** list, select **Dataset**.

- 4 Select the **Record logged workspace data in Simulation Data Inspector** check box, clear the **Enable live streaming of selected signals to Simulation Data Inspector**, and then click **OK**.

Select Signals to Save

Identify signals to display in the Simulink Data Inspector, name the signals if they do not have a name, and set the logging parameters.

- 1 Right-click the Inside Temperature signal from the Signal Builder block and select **Properties**.
- 2 In the **Signal name** box, enter Measured Room Temperature. Select the **Log signal data** check box. A logging badge  appears above the signal line.
- 3 Name and select logging for these signals.

Location of signal	Signal name
Outside Temperature from Signal Builder block	Measured Outside Temperature
Room Temperature from Room Subsystem block	Room Temperature

Run Simulation

After importing data and enabling logging of data for the signals, you can run a simulation.

- 1 Open the model `matlabroot\help\toolbox\simulink\examples\ex_househeat_simulation_prepared.slx` or use the model you prepared for simulation.
- 2 In the model, open the Configuration Parameters dialog box and select the **Solver** pane. Set **Stop time** to 24 (hours), **Type** to Variable-step, and **Solver** to ode45.
- 3 Click the **Run** button  to simulate the model.

The model simulation runs from 0.0 to 24.00 hours using the outside temperature data from the Signal Builder block as input.

Compare Results with Measured Data

Use the Simulink Data Inspector to compare the simulated output signals with measured data.

- 1 In the Simulink Editor toolbar, click the **Simulation Data Inspector** button .

A run appears in the **Runs** pane each time you simulate the model.

- 2 In the Simulink Data Inspector, select each signal check box. Selecting a signal plots the signal in the graph.

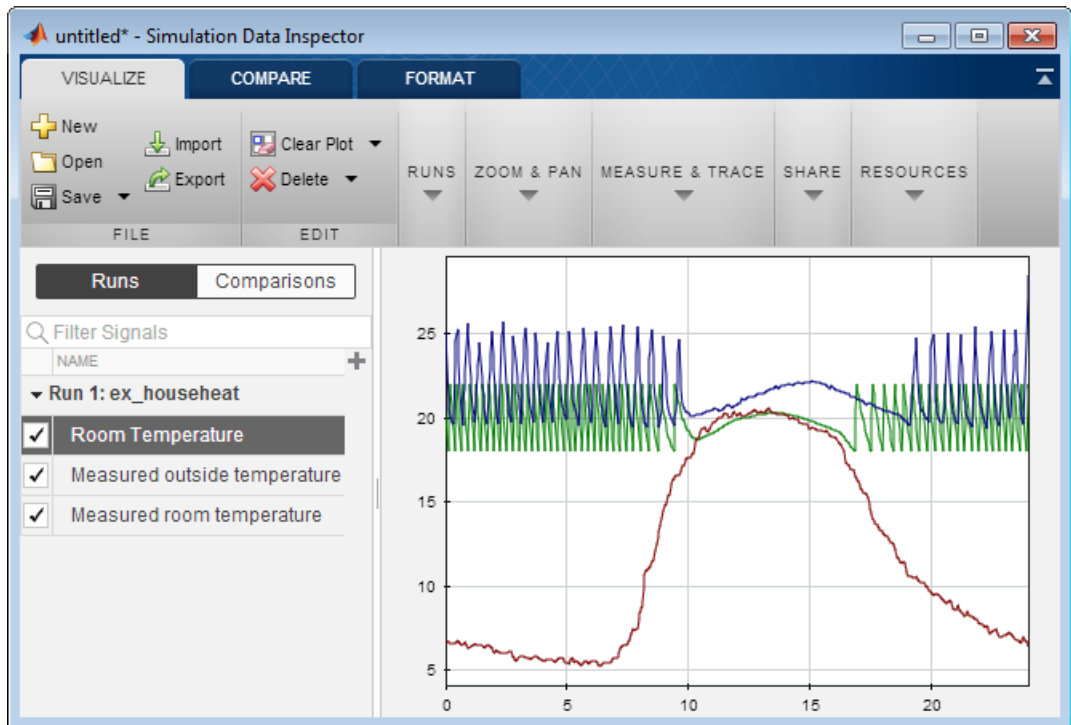

The top signal is the measured inside (room) temperature. The middle signal is the simulated room temperature. The bottom signal is the measured outside temperature.

Determine Changes to Model

One obvious change to the model is the hysteresis of the thermostat. The simulated room temperature oscillates between 18 and 22 degrees around the temperature set point of 20 degrees. The measured room temperature oscillates between 20 and 25 degrees with the same set point.

- 1 Open the Relay block in the Thermostat subsystem.
- 2 Change **Switch on point** from 2 to 0 because the difference between the room temperature and set point is 0.
- 3 Change **Switch off point** from -2 to -5. When the room temperature is 5 degrees above the set point, you want to turn the heater off. The set point is -5 degrees below the room temperature.

Compare Results Between Simulations

Use the Simulation Data Inspector to compare differences between two simulations that use different model parameters.

- 1 Simulate the model.
- 2 Open the Simulation Data Inspector.
- 3 Select **Run1** check boxes for **Measured Outside Temperature** and **Measured Room Temperature**. Select the **Run2** check box for **Room Temperature**.
- 4 Review the signals. The minimum and maximum values for the simulated room temperature now match the measured room temperature values.

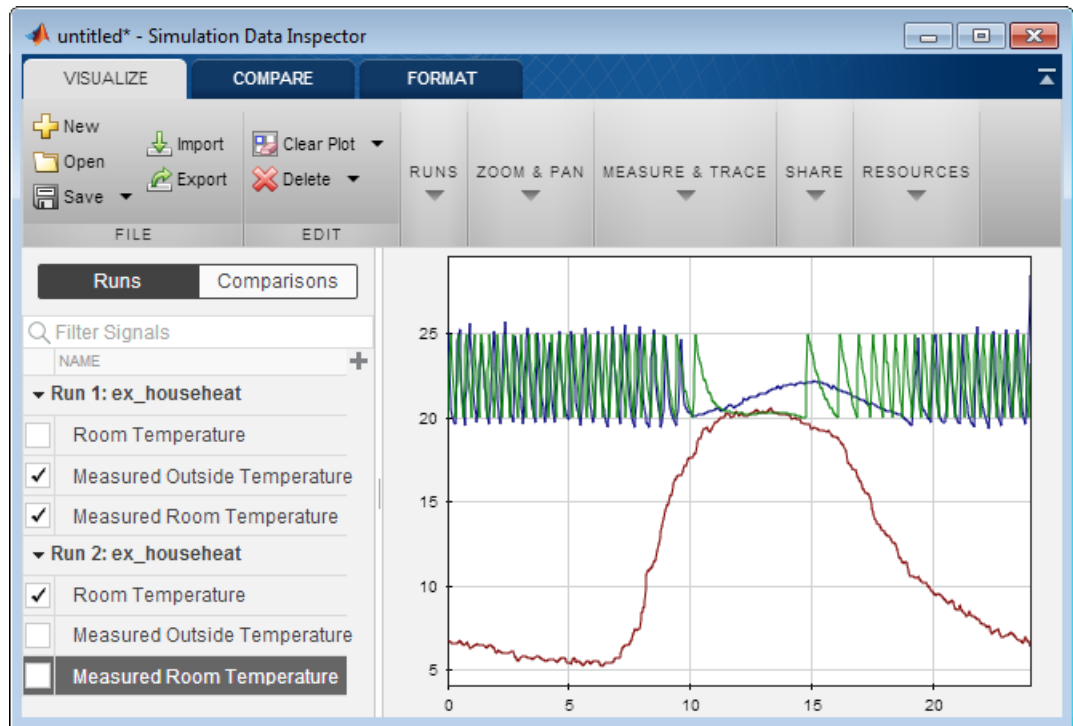

Report and Plot Simulation Results

Create reports and plots from the Simulation Data Inspector.

- 1 In the Simulation Data Inspector toolbar, click **Create Report**.
- 2 In the Create Report dialog box, select **Inspect Signals**. Click **Create Report**. The report opens in a web browser.
- 3 View the report.

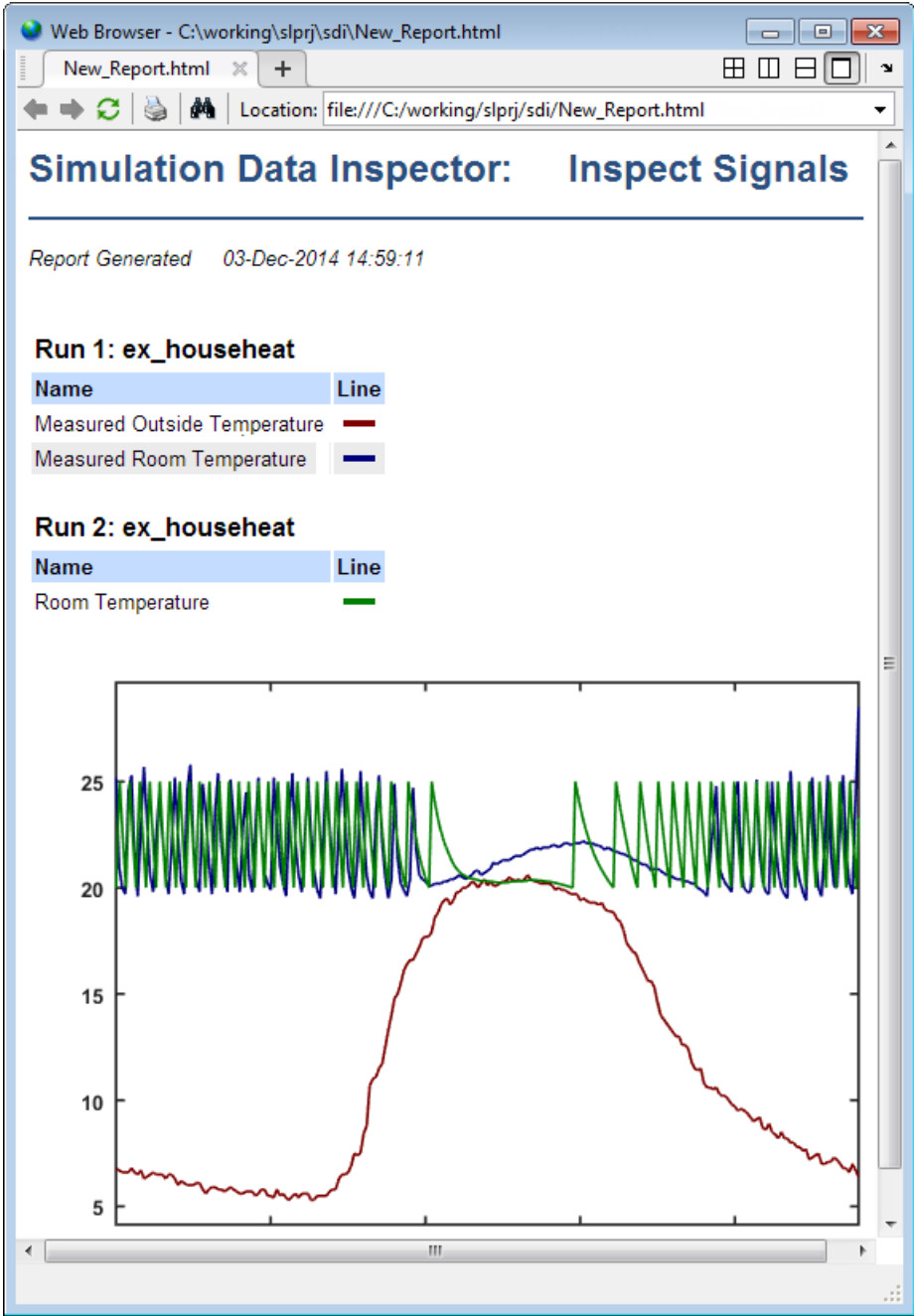

- 4 In the Simulation Data Inspector, click **Send to Figure**. A plot of the simulated signals opens in a MATLAB figure window.

